

**EFFECT OF SOFTWARE-ORIENTED CONCEPT MAPPING ON
PERFORMANCE IN ELECTROCHEMISTRY AMONG SECONDARY
SCHOOL STUDENTS IN KAKAMEGA COUNTY, KENYA**

Masinde Joseph Wangila

**A Thesis Submitted in Partial Fulfillment of the Requirements for the Award of
the Degree of Doctor of Philosophy in Science Education of Masinde Muliro
University of Science and Technology**

JUNE, 2018

DECLARATION

This thesis is my original work, prepared with no other than the indicated sources and support, and has not been presented elsewhere for a degree or any other award.

Signed: _____ Date: _____

MASINDE JOSEPH WANGILA

EDS/H/02/2015

CERTIFICATION

The undersigned certify that they have read and hereby recommend for acceptance of Masinde Muliro University of Science and Technology a thesis entitled “**Effect of Software-Oriented Concept Mapping on Performance in Electrochemistry among Secondary School Students in Kakamega County, Kenya**”

Signed: _____ Date: _____

DR. CATHERINE AURAH

Senior Lecturer, Department of Science and Mathematics Education,
Masinde Muliro University of Science and Technology.

Signed: _____ Date: _____

DR. MARTIN WANJALA

Senior Lecturer, Department of Science and Mathematics Education,
Masinde Muliro University of Science and Technology.

COPYRIGHT

This thesis is copyright materials protected under the Berne Convention, the copyright Act 1999 and other international and national enactments in that behalf, on intellectual property. It may not be reproduced by any means in full or in part except for short extracts in fair dealing so for research or private study, critical scholarly review or discourse with acknowledgement, with written permission of the Dean School of Graduate Studies on behalf of both the author and Masinde Muliro University of Science and Technology.

DEDICATION

I dedicate this thesis whole-heartedly to my dear parents; **Mr. Patrick Wangila** and **Mrs. Dorcas Nekesa**, for their strong belief in the mighty power of very good education, which they both have given me against very many odds. Undeniably so, they indeed will leave behind an admirable legacy that will stand the test of time.

ACKNOWLEDGEMENT

I recognize the following for their contribution towards the success of this work: -

First, I thank the senate of Masinde Muliro University of Science and Technology, for giving me the enviable opportunity to undertake my doctoral studies at this highly cherished institution of higher learning. Secondly, my supervisors; Dr. Catherine Aurah and Dr. Martin Wanjala, for their professional guidance way back from the proposal writing stage to the final draft of this dissertation, which is my undisputed masterpiece. Third, I thank the National Research Fund (NRF), for providing me with a research grant, which financed in entirety, all expenditure I incurred in this study. Four, my beloved wife, Mrs. Grace Nekesa, for happily stepping into my paternal 'shoes' on occasions when the demands of this work restrained me from fulfilling all my family obligations, in addition to her relentless encouragement many a times when the pressure of this academic journey was seemingly insurmountable. Five, I thank my classmates; Mulavu Wycliffe, Ishienyi Polycarp, Michieka Ronald, Wesonga Fanuel, Ocholla Alphayo and the ever-smiling Mbatu Electine. I thank them all for giving me the all important moral support and constructive criticism. Six, I remain thankful to Inspiration Softwares Limited and Smart Technologies Company, both for availing trial versions of their concept mapping products on the internet for free download and unconditional use. I am truly one of the biggest beneficiaries of this generosity. Seven, I thank all the schools I engaged, for sparing their precious time to participate in my study, despite already having busy schedules. Above all, I thank the Almighty God for giving me good health and a very sound mind in all the three years of my PhD studies.

MASINDE J.W.

ABSTRACT

This study determined the effect of using Software-Oriented Concept Mapping on performance in electrochemistry among secondary school students in Kakamega County, Kenya. It was based on David Ausubel's Meaningful Learning Theory, and implemented through a sequential mixed methods approach. Quasi-experimental research design, using non-randomized pretest-posttest control group model, was adopted to implement the study's quantitative phase, while focus group interviews were used for the qualitative phase. Target population was 4,000 form four students and 30 Chemistry teachers from secondary schools in Kakamega County, which offer computer studies. A sample of 400 students and 10 teachers was selected by multi-stage sampling procedure, through a combination of purposive, proportionate stratified and simple random sampling techniques. The dependent variable was academic performance at five levels; achievement, self-efficacy, attitude, motivation and experimental skills, while the independent variable was instructional strategy at two levels; Software-Oriented Concept Mapping and Conventional Instructional Strategies. Students' gender and school type were the intervening variables. The study was piloted two weeks to the actual study, in two secondary schools within Kakamega County. Observation check-lists, close-ended questionnaires and standardized achievement tests were used to collect the study's quantitative data, while focus group interview guides were used to collect qualitative data. All the research instruments were validated using the Rasch Model, while reliability of the quantitative instruments was assessed, also using data from the pilot study, via the internal consistency alpha coefficients method. Percentage validity scores for the instruments ranged between 74 and 86, while their reliability coefficients ranged between 0.729 and 0.877, both measures surpassing the minimum thresholds set by various educational research experts. Frequencies, percentages, means and standard deviations were employed to analyze the collected quantitative data descriptively. The study's null hypotheses were tested inferentially at the 0.05 alpha level of statistical significance, using parametric tests. These included; 2×1 Factorial ANOVA, One-Way ANOVA, Bivariate Pearson's Correlation, ANCOVA and Standard Multiple Linear Regression. Qualitative data on the other hand were analyzed in themes as they emerged. Findings revealed a significantly superior effect of Software-Oriented Concept Mapping on students' academic performance in Electrochemistry when compared to the use of Conventional Instructional Strategies to teach the same topic. These findings have important instructional implications in the field of Chemistry education. It is recommended that Chemistry teachers and students in Kenya should fully incorporate the use of Software-Oriented Concept Mapping in their daily teaching and learning, so as to mitigate the low academic performance currently being reported in the subject at national level.

TABLE OF CONTENTS

DECLARATION	ii
CERTIFICATION.....	ii
COPYRIGHT.....	iii
DEDICATION	iv
ACKNOWLEDGEMENT	v
ABSTRACT.....	vi
LIST OF TABLES	xi
LIST OF FIGURES.....	xii
LIST OF APPENDICES	xiii
ABBREVIATIONS AND ACRONYMS.....	xiv
CHAPTER ONE: INTRODUCTION.....	1
1.1 Main Highlights of Chapter One	1
1.2 Background of the Study.....	1
1.3 Statement of the Problem	7
1.4 Purpose of the Study	9
1.4.1 Objectives of the Study.....	9
1.4.2 Hypotheses of the Study	10
1.5 Assumptions of the Study	10
1.6 Scope of the Study	11
1.7 Limitations of the Study.....	12
1.8 Significance of the Study	13
1.9 Theoretical Framework	13
1.10 Conceptual Framework	16
1.11 Operational Definition of Key Terms	19

CHAPTER TWO: LITERATURE REVIEW	20
2.1 Main Highlights of Chapter Two.....	20
2.2 Overview of Concept Mapping	20
2.3 Concept Mapping Versus Learners’ Self-Efficacy.....	27
2.4 Concept Mapping Versus Learners’ Attitudes	33
2.5 Concept Mapping Versus Learners’ Motivation	40
2.6 Concept Mapping Versus Learners’ Academic Achievement	44
2.7 Concept Mapping Versus Learners’ Use of Experimental Skills.....	51
2.8 Concept Mapping Versus Meaningful Learning Theory	54
2.9 Gaps in Literature Review.....	55
CHAPTER THREE: RESEARCH METHODOLOGY	58
3.1 Main Highlights of Chapter Three.....	58
3.2 Research Design	58
3.3 Location of the Study.....	61
3.4 Target Population.....	62
3.5 Sample Size	63
3.6 Sampling Procedures.....	64
3.7 Research Instruments	69
3.7.1 Students’ Self-Efficacy Questionnaire (SSEQ)	69
3.7.2 Students’ Attitude and Motivation Questionnaire (SAMQ).....	70
3.7.3 Students’ Entry Behavior Achievement Test (SEBAT)	72
3.7.4 Students’ Electrochemistry Achievement Test (SEAT).....	73
3.7.5 Students’ Experimental Skills’ Checklist (SESC)	74
3.7.6 Focus Group Interviews (FGI) Guide.....	75
3.8 Pilot Study	76
3.8.1 Validity of the Research Instruments	76
3.8.2 Reliability of the Research Instruments.....	77

3.9 Data Collection Procedures	78
3.9.1 The Intervention: Concept Mapping Softwares	80
3.9.2 Software Installation: MACOMASO, Inspiration 9.0 and Smart Ideas 5.0	81
3.10 Data Analysis Procedures.....	82
3.11 Ethical Considerations	86
CHAPTER FOUR: PRESENTATION, INTERPRETATION & DISCUSSION.....	88
4.1 Main Highlights of Chapter Four	88
4.2 Data Screening.....	88
4.3 Preliminary Data Analyses.....	89
4.4 Statistical Assumptions	92
4.4.1 Assumptions for One-Way Analysis Of Variance	92
4.4.2 Assumptions for Bivariate Pearson’s Correlation	93
4.4.3 Assumptions for Analysis of Covariance	95
4.4.4 Assumptions for Standard Multiple Linear Regression	96
4.4.5 Assumptions for 2 × 1 Factorial Analysis of Variance	98
4.5 Descriptive Statistics.....	99
4.5.1 Descriptive Analysis of Students’ Pretest Dependent Variables	99
4.5.2 Descriptive Analysis of Students’ Posttest Dependent Variables.....	100
4.6 Inferential Statistics	103
4.6.1 Results of Objective One	103
4.6.2 Discussion of Findings From the First Objective/H _{O1}	105
4.6.3 Results of Objective Two	107
4.6.4 Discussion of Findings From the Second Objective/H _{O2}	109
4.6.5 Results of Objective Three.....	111
4.6.6 Discussion of Findings From the Third Objective/H _{O3}	113
4.6.7 Results of Objective Four	116
4.6.8 Discussion of Findings From the Fourth Objective/H _{O4}	119

4.6.9 Results of Objective Five.....	122
4.6.10 Discussion of Findings From the Fifth Objective/H ₀₅	123
4.7 Qualitative Findings.....	127
4.8 Effect Size	131
CHAPTER FIVE: SUMMARY, CONCLUSIONS & RECOMMENDATIONS	133
5.1 Main Highlights of Chapter Five	133
5.2 Summary of the Study.....	133
5.3 Summary of the Findings	136
5.4 Conclusions From the Main Research Findings	136
5.5 Implications of the Findings.....	139
5.6 Recommendations From the Study.....	140
5.6.1 Recommendations for Policy Makers in the Kenyan Education Sector.....	140
5.6.2 Recommendations for Teachers of STEM	141
5.6.3 Recommendations for Secondary School Students	141
5.7 Suggestions for Further Research.....	143
REFERENCES	145
APPENDICES	159

LIST OF TABLES

Table 1.1: National Mean Scores in Biology and Chemistry from 2011 to 2015	2
Table 1.2: Weighting of Electrochemistry in Past KCSE Theory Papers	3
Table 3.1: Computer Statistics of Western Kenya's Secondary Schools	61
Table 3.2: Sampling Frame.....	64
Table 3.3: Table of Subjects	68
Table 3.4: Test Specification Grid for the SEBAT	72
Table 3.5: Blue Print for the SEAT.....	73
Table 4.1: Proportions of Respondents by their Gender and School Type	89
Table 4.2: Means and Std. Deviations of the Pretest Dependent Variables	99
Table 4.3: Means and Std. Deviations of the Posttest Dependent Variables.....	101
Table 4.4: Analysis of Posttest Achievement by Gender and School Type	102
Table 4.5: One-Way ANOVA on Students' Achievement Scores	104
Table 4.6: Correlation Coefficients of Posttest Achievement vs. Self-Efficacy	108
Table 4.7: ANCOVA Tests of Between Subjects Effects	112
Table 4.8: Standard Multiple Linear Regression Analysis.....	117
Table 4.9: 2×1 Factorial ANOVA on Posttest Achievement Scores	122
Table 4.10: Summary of Emergent Themes From Focus Group Interviews.....	131

LIST OF FIGURES

Figure 1.1: A Typical Concept Map on the Topic of Matter.....	5
Figure 1.2: Rote-Meaningful Learning Continuum	14
Figure 1.3: Model Postulating how the Study Variables Interacted	17
Figure 3.1: Model showing how the Quasi-Experiment was done	59
Figure 3.2: Formula that was used to Calculate the Study's Sample Size	63
Figure 3.3: Computations of No. of Schools of Each Type Needed	65
Figure 3.4: Sample Software-Drawn Electrochemistry Concept Map.....	82
Figure 4.1: Linear Regression Equation Predicting Students' Achievement	118
Figure 4.2: Formula that was used to Calculate Effect Size.....	132
Figure 5.1: Model Postulating how SOCM can be used to Improve Performance.	138

LIST OF APPENDICES

Appendix 1: Researcher's Introduction Letter.....	159
Appendix 2: Research Permit	160
Appendix 3: Research Authorization Letter	161
Appendix 4: Map of the Research Area	162
Appendix 5: Students' Self-Efficacy Questionnaire (SSEQ)	163
Appendix 6: Students' Attitude and Motivation Questionnaire (SAMQ).....	165
Appendix 7: Students' Entry Behavior Achievement Test (SEBAT).....	168
Appendix 8: Marking Scheme for the SEBAT	174
Appendix 9: Students' Electrochemistry Achievement Test (SEAT).....	178
Appendix 10: Confidential for the Electrochemistry Practical.....	182
Appendix 11: Marking Scheme for the SEAT.....	183
Appendix 12: Manual for 'MACOMASO' Concept Mapping Software.....	185
Appendix 13: Students' Experimental Skills Checklist (SESC).....	186
Appendix 14: Focus Group Interview (FGI) Guide	187
Appendix 15: Students' Informed Consent Form.....	191
Appendix 16: Request Letter to Experts for Validation of Instruments.....	192
Appendix 17: Schools in the Research Area that Offer Computer Studies.....	194
Appendix 18: Normality Tests for the Dependent Variables	196
Appendix 19: Test of Homogeneity of Variances on the Dependent Variables.....	197
Appendix 20: Letter of Appreciation to Participants of the Study	198
Appendix 21: Return Rates for the Research Instruments	199
Appendix 22: Completion Rates for the Research Instruments.....	200
Appendix 23: Incentive for Respondents of the Study	201
Appendix 24: Manual for Inspiration 9 Concept Mapping Software	202

ABBREVIATIONS AND ACRONYMS

ANCOVA	Analysis of Covariance
ARCS	Attention, Relevance, Confidence, Satisfaction
CIS	Conventional Instructional Strategies
FGI	Focus Group Interview
KCSE	Kenya Certificate of Secondary Education
KNEC	Kenya National Examinations Council
MACOMASO	Masinde's Concept Mapping Software
MLT	Meaningful Learning Theory
MoE	Ministry of Education
NACOSTI	National Commission for Science, Technology & Innovation
SAMQ	Students' Attitude and Motivation Questionnaire
SEAT	Students' Electrochemistry Achievement Test
SEBAT	Students' Entry Behavior Achievement Test
SESC	Students' Experimental Skills Checklist
SMLR	Standard Multiple Linear Regression
SOCM	Software-Oriented Concept Mapping
SSEQ	Students' Self-Efficacy Questionnaire
STEM	Science, Technology, Engineering and Mathematics

CHAPTER ONE:

INTRODUCTION

1.1 Main Highlights of Chapter One

This chapter highlights on the; background of this study, statement of the problem, purpose of the study, assumptions of the study, scope of the study, limitations of the study, significance of the study, theoretical framework, conceptual framework and operational definition of key terms used in this work.

1.2 Background of the Study

One of the roles of science education in the world is to develop in learners a sense of curiosity, which will help them understand how and why phenomena happen. Chemistry education specifically aims at inculcating in students a positive attitude towards appreciating the usefulness and relevance of scientific work in the world today (Iftekhhar, 2013). In Kenya, Chemistry education aims at providing knowledge that prepares learners for further study, vocations and to appreciate their environment (KICD, 2002). Chemistry can be viewed as a 'bridge' because it incorporates knowledge acquired from a variety of subjects like Physics and Biology, which makes it to have a wide range of applications in different fields like Medicine, Agriculture, Biotechnology and Engineering (Iftekhhar, 2013; Masinde, Wanjala and Michieka 2015). A lot of emphasis is therefore placed on the application of the knowledge of Chemistry, in order to solve environmental and other issues that currently affect the Kenyan society.

The whole process of teaching and learning Chemistry continues to face different challenges on the global scale. In developing countries, the major problem is inadequate allocation of funds towards promoting quality teaching. In India for instance, the prime minister, Dr. Mammohan Singh announced in the 99th Indian Science Congress that his government would double the allocation of funds towards science education by the year 2017 (Iftekhhar, 2013), which has already happened (Padma, 2015).

In Kenya however, the biggest problem currently lies in the consistently poor performance by students in the subject, in the annual Kenya Certificate of Secondary Education (KCSE) examinations. Biology, which is viewed as a subject of relatively similar difficulty level and students' enrolment has always outshined Chemistry in KCSE, as attested by the compiled results, shown in Table 1.1.

Table 1.1: National Mean Scores in Biology and Chemistry from 2011 to 2015

YEAR	2011	2012	2013	2014	2015
Biology	42.65	45.54	44.01	46.98	43.72
Chemistry	39.55	38.65	39.65	37.95	39.01

Source: KNEC Annual KCSE Reports, (2011 - 2015)

As Table 1.1 reveals, in no single year has Chemistry performed better than Biology for the last five years. This situation has attracted concern from different quarters in the Kenyan education sector, all seeking to know the reason. Some of the reasons that have been attributed to this poor performance are; students' low self-efficacy (MoE, 2015), low motivation (KNEC, 2014) and negative attitude towards abstract topics (Masinde *et al*, 2015). All these factors boil down to the use of conventional

instructional strategies of instruction, whose rampant use has been found ineffective, especially in abstract and difficult topics (Beck, 2009).

Not all topics in the Chemistry curriculum are a problem to students in secondary schools however. A question-by-question analysis of previous national Chemistry examinations has revealed that topics which are abstract are performed much more dismally than those that are not. Electrochemistry is one such topic, which is very frequently tested, yet students perform very poorly in its test items (KNEC, 2016). Table 1.2 gives a breakdown of the number of marks allocated to questions from this topic in past KCSE examinations.

Table 1.2: Weighting of Electrochemistry in Past KCSE Theory Papers

YEAR	WEIGHTAGE (MARKS ALLOCATED)		
	PAPER 1	PAPER 2	TOTAL
2016	8	5	13
2015	6	8	14
2014	5	6	11
2013	3	9	12
2012	4	7	11

Source: KCSE Chemistry past papers, (2012 - 2016)

Data provided in Table 1.2 proves that electrochemistry is indeed a key topic in Chemistry, whose importance is underscored by the fact that it is allocated such a relatively high number of marks, and is tested every year in KCSE papers 233/1 and 233/2. Being an abstract topic, conventional instructional strategies are obviously not the most effective when teaching or learning it. The worry however is that many teachers still use them in this topic, probably because they are convenient in the sense that when used, a lot of content is covered within a very short period of time (Dimitrios, Labros, Kakkos, Koutiva and Koustelios, 2013).

Which strategy is best for teaching and learning of electrochemistry? Research reveals that using hands-on student centered instructional approaches plays a vital role in improving learners' self-efficacy, attitude, motivation and achievement in several subjects (Dimitrios *et al*, 2013). Students with high self-efficacy, positive attitude, high motivation and achievement in Chemistry are therefore expected to perform very well in the subject, because these are the all-important contributors of high academic achievement (Cheema and Mirza, 2013; Singh and Moono, 2015; Wilson and Kim, 2016).

Teachers of Chemistry in the country should therefore play their crucial part in addressing this problem by using such novel instructional strategies to deliver abstract content and also by encouraging their students to use similar learning strategies to carry out their private revision of all concepts that they would have been taught. This approach should no doubt have a positive impact on the previously mentioned aspects of academic performance, according to the researcher's informed projection. Perhaps Software-Oriented Concept Mapping (SOCM) could be implemented in all the abstract Chemistry topics, so as to address the pitfalls of Conventional Instructional Strategies.

Concept Mapping, when used as an instructional strategy alongside other conventional strategies, has been found to be very effective in improving learners' self-efficacy, motivation, attitude, experimental skills and achievement of students in many different subjects, or so are findings from empirical studies (Riga, 2015; Wambugu, Changeiywo and Ndiritu, 2014; Wilson and Kim, 2016; Zadeh, Gandomani, Delaram and Yekta, 2015). So what is Concept Mapping? This is a

graphical way of representing and structuring knowledge by use of a concept map (Novak, 2010a). A typical concept map represents relationships between ideas, images or words, just like a sentence diagram represents its grammar, a road map shows location of highways and towns, and a circuit diagram represents the workings of electrical appliances (Moreno, Jelenchick and Christiakis, 2013). In every concept map, ideas and information in circles and boxes are connected using labeled arrows, in a downward branching hierarchical structure. Figure 1.1 shows a typical example of a concept map showing the interrelationships between the different concepts on the Science topic of Matter.



Figure 1.1: A Typical Concept Map on the Topic of Matter

(Source: Centre for Technology and Teacher Education)

As Figure 1.1 shows, all the important relationships between concepts in any given topic can be expressed very easily using linking phrases on top of the arrows, also in a downward-branching and hierarchical structure (Moreno *et al*, 2013). Concept maps have been proven to be effective tools for stimulating generation of important ideas, aiding creative thought, brainstorming and also communicating very complex ideas (Novak, 2010b). Concept maps are mostly drawn using paper and pencil, but with recent advances in technology today, there are many computer programmes

that can also be used to do this far much easier. When the latter is done, the current study termed it “Software-Oriented Concept Mapping”.

Software-Oriented Concept Mapping (SOCM) is considered superior to other forms of concept mapping in the sense that being an interactive computer-based approach, it stimulates creative thinking skills, improves communication skills, and at the same time keeping the learner up-to-date with their computer skills, which are much needed on the job market in the ‘digital’ world of today (Riga, 2015).

Implementation of SOCM in Kenya could therefore provide a timely intervention to the inappropriate and insufficient ways through which students have been learning electrochemistry and other abstract topics. It was expected that using SOCM alongside the Conventional Instructional Strategies (CIS), would be a breakthrough in ameliorating students’ self-efficacy, attitude, motivation, experimental skills and achievement, for good academic performance, which is badly needed in Chemistry education by the Kenyan students of today.

Apart from being used as an instructional strategy by teachers, Concept Mapping can also be used as a metacognitive learning strategy by students, whereby instead of reading their hand written notes during private study sessions, they could construct and revise concept maps (Novak, (2010a). Even though a lot of research has been done with regard to metacognition, many conflicting findings continue to emerge. For instance, a study by Coutinho (2006), as reported in Aurah, (2013), revealed that students who were more metacognitive according to quantitative and self-reported measures of metacognitive behaviors, did not necessarily perform at

statistically higher levels, on difficult test items on the graduate record exam, than did the less metacognitive ones. Aurah further mentions in her work, that Nietfeld, Cao and Osborne, (2005) were able to demonstrate that the quality of monitoring behavior did not necessarily improve, even when learners attend specifically to this aspect of their own metacognitive behavior. In all these studies, students may have lacked a knowledge base on which to be metacognitive or that their background knowledge was insufficient to accurately solve the problems. In addition, both studies used instruments that were quantitative in nature.

Incorporating qualitative analyses may have complemented these findings, like it was done by Akana and Yamauchi, (2004), who used metacognitive skills to improve students' behaviors. The metacognitive strategies, as used in their study, led to improved performance. A different study by Aurah, (2013) used the mixed methods approach, in which both quantitative and qualitative strategies were applied, yielding positive results with respect to students' self-efficacy, motivation and achievement in Biology. It is on this basis that the present study conducted a mixed methods approach to investigate the effect of SOCM, as both an instructional and metacognitive strategy on academic performance in electrochemistry, among secondary students in Kakamega County, Kenya.

1.3 Statement of the Problem

It is apparent that of all the science subjects being offered at secondary school level in Kenya currently, Chemistry is the worst performed, if the analyses of previous KCSE results provided by KNEC are anything to go by. The subject has always ranked poorly in KCSE for the last five consecutive years, especially when

compared to Biology, which has a similar students' enrollment. Reasons leading to this predicament are well documented and among them are students' low self-efficacy, low motivation and negative attitude towards abstract topics. The widespread use of and overreliance on Conventional Instructional Strategies in abstract topics has only made matters worse.

Electrochemistry, a very important topic with a wide range of applications in industry, is one such topic, no wonder it is frequently tested in the national examinations, with high weightage given to its question items in the theory papers. Poor performance in Electrochemistry question items should therefore be everyone's concern because it will eventually compromise production and development. However, the Conventional Instructional Strategies, which have been criticized for being mainly teacher-centered, continue to be used to teach it. This therefore means students will continue to perform poorly in the subject at national level unless research about more effective student-centered and metacognitive instructional strategies is done in the country and its recommendations adopted.

Software-Oriented Concept Mapping is one good example of a student-centered instructional strategy, which incorporates technology to promote creativity in the way learners think about, visualize and relate different concepts in a topic or subject. Elsewhere, this strategy has been found to impact positively on several aspects of students' academic performance but research about its use in the Kenyan context is scanty at the moment and hence this study couldn't have been done at a better time. In fact, there is no study known to the researcher so far, about its application

anywhere in Kakamega County. It is on these premises that the current study was carried out.

1.4 Purpose of the Study

This study sought to establish whether the use of Software-Oriented Concept Mapping as an instructional strategy is more effective than the use of Conventional Instructional Strategies, with respect to academic performance in Chemistry, focusing on the abstract topic of electrochemistry, among secondary school students in Kakamega County, Kenya. In this context, students' self-efficacy beliefs, attitude, motivation, experimental skills and achievement were the key indicators of their academic performance.

1.4.1 Objectives of the Study

The study was guided by five objectives. These were: -

- i) To determine whether there is a difference in achievement among students taught electrochemistry using SOCM and those taught via the CIS
- ii) To determine the association between students' self-efficacy and achievement in electrochemistry when taught using SOCM and the CIS
- iii) To determine the extent to which students' experimental skills and attitude interact to influence their achievement in electrochemistry when taught using SOCM and the CIS
- iv) To establish the extent to which learning indicators could predict students' achievement in electrochemistry when taught using SOCM and the CIS

- v) To establish the differential effects of SOCM and the CIS on students' achievement in electrochemistry by gender and school type

1.4.2 Hypotheses of the Study

Five null hypotheses were formulated from the aforesaid research objectives, and each was later tested inferentially at the 0.05 alpha level of statistical significance: -

- H₀₁ There is no significant difference in achievement among students taught electrochemistry using SOCM and those taught via the CIS
- H₀₂ There is no significant association between students' self-efficacy and achievement in electrochemistry when taught using SOCM and the CIS
- H₀₃ Students' experimental skills and attitude do not significantly interact to influence achievement in electrochemistry when taught using SOCM and the CIS
- H₀₄ Learning indicators cannot predict students' achievement in electrochemistry when taught using SOCM and the CIS
- H₀₅ There are no significant differential effects of SOCM and the CIS on students' achievement in electrochemistry by gender and school type

1.5 Assumptions of the Study

It was assumed in this study that form four students would not have learnt electrochemistry yet and that the true association between students' achievement and their self-efficacy, motivation, attitude and experimental skills in Chemistry was linear. Furthermore, achievement, self-efficacy, attitude, motivation and experimental skills in Chemistry were normally distributed variables. It was further

assumed that assignment of students into streams in the selected schools was usually done without bias, and hence findings of this study would be generalized to all secondary schools in the research area, which possessed similar characteristics as those that were used in this study.

Additionally, it was assumed that not all Chemistry teachers and students had any prior knowledge about SOCM as an instructional strategy and were therefore using the CIS in their daily teaching and learning. With respect to class size, it was assumed that form four classes in the research area had an average of 40 students per stream, going by national statistics. Finally, it was assumed that all respondents would give accurate information about themselves in all self-reporting instruments that were used to collect data for this study. Lastly, it was assumed that students already had the experimental skills under investigation.

1.6 Scope of the Study

Different teachers use different approaches to teach Electrochemistry. However, in this study, intervention involved the use of SOCM only. There are many factors that affect students' academic achievement in a given subject or topic. This study confined itself to students' experimental skills, self-efficacy, attitude, motivation and academic achievement as the measured variables. The whole topic of electrochemistry was taught because it is one of the topics in Chemistry that is tested frequently, yet students continue to perform dismally in it, as has been shown earlier.

Only form four students and their Chemistry teachers were allowed to participate in the study because electrochemistry is taught at this level in the curriculum. Only secondary schools in the study area, which offer computer studies, were used because it is such schools that are equipped with sufficient number of computers, with which SOCM could be implemented. Schools in Kakamega County were used because the county has the highest computer to student ratio in the region, going by the data collected in the baseline study.

1.7 Limitations of the Study

Several factors, which were beyond the researcher's control, might have affected the research methodology and consequently the interpretation of its findings. First, since the study aimed to establish cause-effect relationships between the independent and dependent variables, random selection of the subjects was required. However, full randomization was not done because of the static nature of classes and other ethical issues that had to be considered because the research was in a school setting. Nevertheless, the researcher assigned participants randomly into experimental and control groups, so that this limitation could not adversely affect the study's external validity.

Secondly, though the study was ideally expected to last for 22 lessons (four weeks), it lasted longer in some schools because of interrupted school programmes for varying reasons. The researcher however, made prior visits to the participating schools in order to make arrangements with school authorities to ensure smooth running of the study, as had been scheduled. Lastly, it was not possible to separate female and male students in co-educational schools that were used for this study,

due to ethical issues. To ensure that this limitation did not compromise the study's internal validity, the researcher statistically controlled for students' gender by treating it as a covariate during data analysis.

1.8 Significance of the Study

Findings of this study are of importance to several parties, who might use the research data to make crucial decisions about future policy action. To science educators, it equips them with current knowledge about a more effective, student-centered instructional strategy for abstract or difficult topics, whose lack thereof has led to some teachers passing over such topics to their colleagues to teach on their behalf. To Chemistry students in Kenyan secondary schools, it may lead to improved self-efficacy, attitude, motivation, achievement and experimental skills, hence better national performance in the subject in KCSE. To the MoE, it may provide useful points of reference when making decisions on matters instructional policy.

1.9 Theoretical Framework

This study was grounded in the Meaningful Learning Theory (MLT). The theory, which was advanced by David Ausubel, contrasts meaningful learning from rote learning. Ausubel, (2000) posits that to learn meaningfully, students must relate new knowledge, concepts and propositions to what they already know (Novak, 2011). He proposed the notion of an advance organizer, as a way to help learners link their ideas with new material or concepts.

The MLT also suggests that new concepts to be learnt must be incorporated into more inclusive concepts or ideas. These more inclusive concepts or ideas are referred to as “advance organizers”, which could be in the form of verbal phrases, or graphic representations (Ausubel, 2000). Concept maps, as were used in the present study, fall in the latter category. The basic tenets of the meaningful learning model are as shown in Figure 1.2.

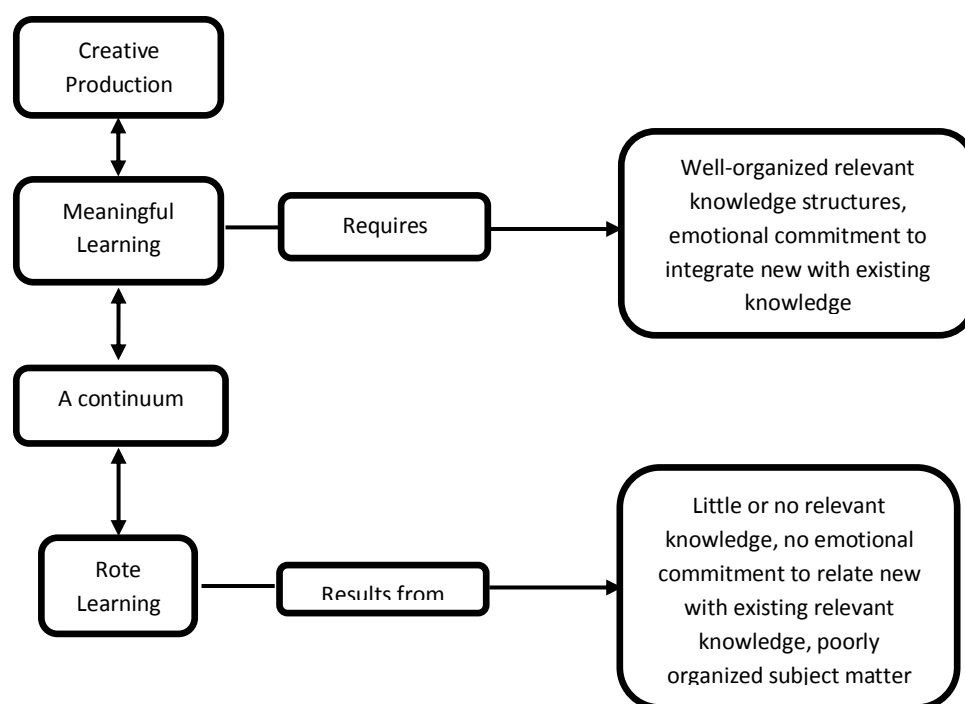

Figure 1.2: Rote-Meaningful Learning Continuum

Source: Novak, (2011)

Characteristics of meaningful learning include; (i) non-arbitrary, non-verbatim and substantive incorporation of new knowledge into cognitive structures. This aspect is bound to boost students’ experimental skills in Chemistry (Zadeh *et al*, 2015), hence the choice of experimental skills as one of the variables investigated in this study, (ii) deliberate effort to link new knowledge with higher order concepts in the

cognitive structure. This aspect of the MLT is expected to improve students' self-efficacy in Chemistry (Wilson and Kim, 2016), and hence its selection as a variable that was investigated in this study, (iii) learning is related to experiences with events or objects. This aspect of the MLT is bound to improve students' motivation to learn Chemistry (Karakuyu, 2010), and this is the reason why motivation was on the list of this study's dependent measures (iv) affective commitment to relate new knowledge to prior learning. This aspect of the MLT is bound to bolster students' attitude towards various aspects of instruction (Masinde *et al*, 2015), hence the choice of attitude as one of the measured variables in this study.

Rote learning on the other hand is (i) arbitrary, verbatim, non-substantive incorporation of new knowledge into the cognitive structure, (ii) no effort to integrate new knowledge with existing concepts in the cognitive structure, (iii) learning is not related to experience with events or objects and (iv) no effective commitment to relate new knowledge to prior learning (Novak, 2011).

All these characteristics could as well be associated with the CIS used in Chemistry (Schunk, 2006), which have been blamed for the low achievement in the subject nationally for the last ten years. MLT therefore played the all-important role of pointing to the direction that needed to be taken, so as to fix this problem. Ausubel, (2000) believed that learning proceeds in a top-down, or deductive manner. His theory consists of three phases, the first of which is presentation of an advance organizer. In this study, incomplete concept maps were presented to learners at the beginning of each electrochemistry lesson, as advance organizers.

The second stage in this theory is presentation of a learning task or material, which was initiated in this study by teachers, who asked their students to complete the concept maps after being taught electrochemistry using the conventional methods. The last stage is strengthening of the cognitive organization, which was carried out in this study by discussion and revision of the student-drawn concept maps, through facilitation from Chemistry teachers.

Students in experimental groups of this study were asked to use concept maps to revise electrochemistry, instead of using their exercise and text books as is always the routine. It was hoped that this would be a better strategy than the conventional approaches because a well drawn concept map is able to shorten a very long topic by presenting all its main concepts in one page, on one big and elaborate concept map (Novak, 2010b).

1.10 Conceptual Framework

A conceptual framework depicts a researcher's pictorial understanding of how his or her research variables interact with each other (Ravitch and Riggan, 2012). Relationships between variables in this study were as summarized in Figure 1.3, the study's conceptual model, which indicates that instructional strategy (SOCM and the CIS) directly affected academic performance. This implies that students' scores on this study's performance scales depended on the instructional strategy that was used to teach them. This arrangement means students' academic performance was the dependent variable at five levels: - achievement, attitude, motivation, self-efficacy and electrochemistry experimental skills, while instructional strategy was the independent variable at two levels; SOCM and the CIS.

It can be deduced from Figure 1.3 that attitude and experimental skills of students in electrochemistry were believed to interact and influence their academic achievement in the said topic. This implies that students with positive attitude towards electrochemistry may perform well or poorly in the topic depending on how well they utilize their experimental skills and vice versa. This relationship was investigated under the third objective of this study.

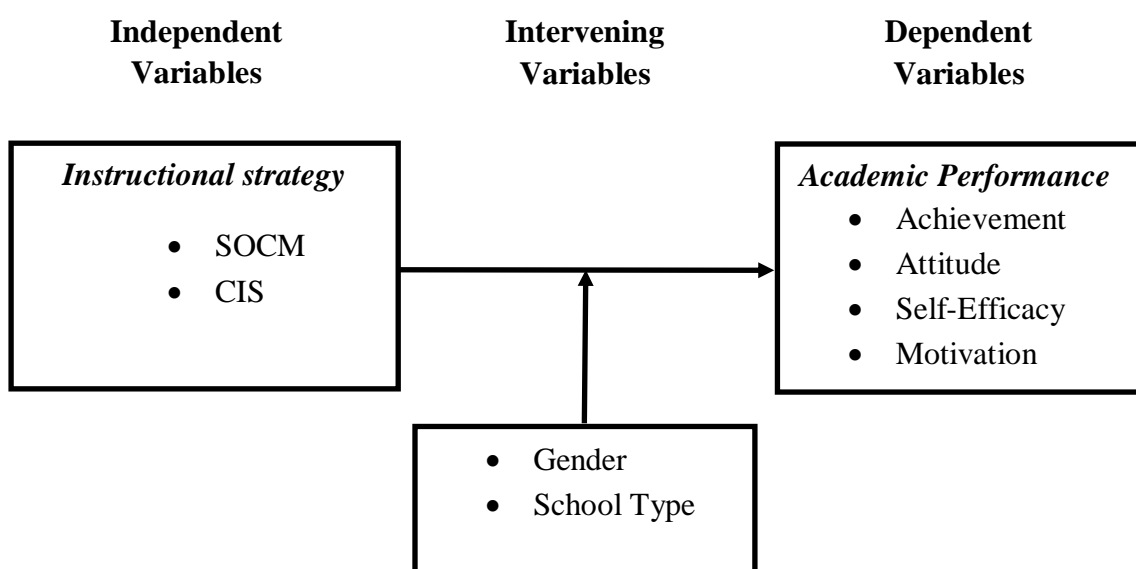

Figure 1.3: Model Postulating the Interaction between Research Variables

(Source: Researcher)

Additionally, Figure 1.3 suggests an association between students' self-efficacy, motivation, attitude and experimental skills with respect to academic achievement. This association was investigated under the fourth objective of this study. Furthermore, Figure 1.3 illustrates that students' achievement might differ by gender

and school type. These were therefore the study's intervening variables, which were only controlled for statistically to address the fifth objective of this study.

The single pointed arrows in the framework indicate a one-way relationship between the variables in question. Intervening variables on the other hand can be identified in the framework by the upward pointing arrow.

1.11 Operational Definition of Key Terms

The following key terms have frequently been mentioned in this work, but their contextual meaning may differ from the conventional one. Their definitions as given below may therefore only apply to this study.

Achievement:	Students' scores in a Chemistry test expressed in percentage (%).
Concept Mapping:	A technique for visualizing relationships between different concepts in order to organize, structure and retrieve knowledge more easily
Experimental skills:	Learners' use of scientific skills namely; arranging, connecting, assembling, reading, recording, rinsing and polishing, so as to solve practical Chemistry questions
Learning indicators:	Students' self-efficacy, attitude, motivation and Chemistry experimental skills
Motivation:	Students' perceived likelihood of success in future Chemistry tasks
Performance:	Students' scores on a self-efficacy, attitude, motivation, experimental skills and achievement test scales
Self-Efficacy:	A learner's belief in his/her ability to understand Chemistry concepts and pay attention until the end of a learning session
SOCM:	The use of computer interactive software to generate concept maps for instructional purposes

CHAPTER TWO:

LITERATURE REVIEW

2.1 Main Highlights of Chapter Two

This chapter gives brief highlights of previous studies related to concept mapping in the educational setting, and its effectiveness on various learning outcomes, with specific focus on students' self-efficacy, attitude, motivation, academic achievement and experimental skills, which were the variables of interest in this study. It further discusses how concept mapping has been done in different parts of the world and the findings so far. The chapter finally pinpoints major areas of convergence and divergence in the literature and existing gaps, some of which this study hopes to fill.

2.2 Overview of Concept Mapping

Concept mapping is a technique for visualizing relationships among different concepts (Novak, 2010b). Research indicates that concept mapping is an effective instructional strategy that precipitates meaningful learning in child and adult learners in a variety of domains, such as Genetics, Mathematics, Physics, Chemistry and English (Khajavi and Ketabi, 2012; Nbina and Viko, 2010; Ferla, Valcke and Cai, 2009; Nelson, 2007).

When implemented correctly and thoroughly, concept mapping is a powerful way for students to reach high levels of cognitive performance. A concept map is also not just a learning tool, but an ideal evaluation tool for educators measuring the growth of and assessing students' learning (Bell, 2017). As students create the concept maps, they reiterate ideas using their own words and help identify incorrect ideas

and concepts. Educators are able to see what students do not understand, providing an accurate, objective way to identify areas in which students do not yet grasp concepts correctly.

Concept mapping strategies have enjoyed wide use among science educators, as tools to gauge both prior knowledge and student learning. Engaging students in the process of concept mapping involves them in exploring their understandings of particular concepts and provides them with a roadmap for the construction of new knowledge (Novak, 2011). Additionally, concept mapping can be a window into students' mental models and cognitive links to influence their future learning. Consequently, concept mapping can promote student learning, as well as provide teachers with valuable insights into student conceptions of ideas relating to different aspects of learning (Bell, 2017).

Concept Maps differ from other types of mapping systems, such as Knowledge Maps, Conceptual Graphs, and Mind Maps because of: their grounding in Ausubel's Assimilation theory of learning, their semantic and syntactical organization, the nature of concepts that comprise the nodes in a Concept Map, and the unconstrained nature of linking phrases (Canas *et al*, 2003). A standard procedure for Concept Map construction involves defining the topic or focus question, identifying and listing the most important or "general" concepts that are associated with that topic, ordering the concepts from top to bottom in the mapping field, then adding and labeling linking phrases. Once the preliminary concept map has been built, cross-links are identified, added and reviewed for completeness and correctness (Novak, 2010a).

Several alternative approaches to concept map construction do exist. Some of these mapping variations are based on the use of software tools, the pre-specification of concepts and/or link labels, and individual versus collaborative mapping (Novak, 2011). Individually produced concept maps and those produced by groups can be made with assistance of human or software-oriented aid. Many facilitation procedures are possible in concept map construction, ranging from support provided to novices who are learning to create concept maps, to support of a group of experts who work in conjunction with a facilitator or knowledge engineer (Bell, 2017).

Efficacy studies reveal that when Concept Mapping is used in a course of instruction, it is better that it be an integral, on-going feature of the learning process and not just some isolated “add-on” at the beginning or end (Novak, 2006). In this regard, Concept Mapping appears to be particularly beneficial when used in an on-going way to consolidate or crystallize educational experiences in the classroom, for example, a lecture, demonstration, or laboratory experience. In this mode, learners experience an educational event and then use Concept Mapping in a reflective way to enhance the learning from the event. There is also indication that learning effects are enhanced when in the course of Concept Mapping, learners adopt an active, deep and questioning approach to the subject matter. Such active, self-engaging, transformational interaction with learning material has been suggested to enhance learning in general and this appears to carry over to learning with Concept Maps as a tool (Novak, 2011).

When Concept Mapping is compared with other sorts of activities such as outlining or defining concepts which can induce the learner to take a thoughtful, systematic approach to engaging subject matter, the positive benefit of Concept Mapping often diminishes, a finding noted also in the review Bamidele *et al*, (2013). However, even in these situations, it appears that Concept Mapping is especially good in comparison to other interventions, for the learning of relationships among concepts.

From several of the studies reviewed, there is indication that Concept Mapping may be particularly beneficial for lower ability learners, partly because it does induce the active, inquiring, orderly approach to learning that is likely a more natural part of the higher ability student's approach to learning (Bell, 2017; Canas *et al*, 2003). On the other hand, when learners are not yet facile with constructing Concept Maps, there is some indication that the cognitive load of creating maps from scratch may hinder learning. When students are novice mappers, other "scaffolded" ways of interacting with Concept Maps, for example, filling in the blank content nodes of a Concept Map already containing the labeled relationships of a completed Concept Map, may be beneficial (Bell, 2017).

Numerous educational applications of Concept Mapping can be identified. Including as; (i) a scaffold for understanding, (ii) a tool for the consolidation of educational experiences, (iii) a tool for improvement of affective conditions for learning, (iv) an aid or alternative to traditional writing assignments, (v) a tool to teach critical thinking, (vi) a mediating representation for supporting interaction among learners, and (vii) an aid to the process of learning by teaching (Martin, 1994). Several studies were examined in which Concept Mapping was used to identify students' current

understandings, misconceptions and conceptual change. Concept Maps have been used in collaboration and cooperative learning, and as a formal assessment tool. Concept Maps have been used to organize and present information, including use as an Advance Organizer, use by instructors for course or curriculum design, and use as a navigational aid in hypermedia (Canas *et al*, 2003; Nelson, 2007; Novak, 2006; Bell, 2017; Martin 1994; Hendry and King, 1994).

A major lesson learned regarding the use of Concept Maps in educational settings is that the nature of the learner's mental interaction with the subject matter to be learnt during the building of the concept map is important to the learner's achievement. The interaction cannot be passive if learning is to occur. Bell, (2017) Concept Mapping is greatly enhanced when a teacher (or other "facilitator" working with a learner), the learner him or herself, a device (e.g., computer generated prompts), or the nature of the interaction in a learning group promotes active inquiry and organization by asking questions, prompting for explanation and justification, requesting clarification, requesting embellishment, encouraging connection among elements, encouraging the learner to formulate questions about the material, all these according to Bell, (2017).

Another lesson is that with regard to scoring methods for Concept Maps, a number of methods have been developed which do not seem to be as indicative of the structure of knowledge as traditional Concept Map scoring methods, but rather are focused on the proposition or concept level (Riga, 2015). These methods may show greater agreement with traditional measures of achievement but basing assessment of achievement on the inclusion of simple propositions or concepts is unlikely to

motivate learners to learn new information in a meaningful and structured way Novak, (2011). With regard to the use of Concept Maps for navigation, another lesson is that the structure of Concept Maps that are carefully constructed may assist learners in finding information more quickly.

However, maps constructed to be effective in communicating the structure of information cannot be too complex. Training in concept mapping may be useful in helping learners use the linking phrases and concepts in the map more effectively for learning (Hendry and King, 1994). However, to some extent the value of the map will depend on the user's goals - whether those goals are to find the answer to a specific question or problem, or to learn more about the structure of a particular domain of knowledge. Map characteristics such as organization, color coding, and animation may be important in determining the utility of concept maps used for navigation; however these characteristics are largely unexplored, except in anecdotal evidence.

Finally, both concept maps and collaborative learning have been shown to have educational benefits. Another lesson is that the two can be combined to produce synergistic beneficial effects (Bell, 2017; Wilson, 1996). This can be useful in promoting collaborative activities among learners and in enhancing the process of knowledge construction. More active involvement in learning can be provided by the concurrent use of these techniques. Current technology and software have provided the capability of networked and remote collaboration. This makes the benefits of collaborative concept mapping more accessible for both educational and business uses (Riga, 2015).

Concept Mapping has had widespread use as a Knowledge Elicitation (KE) tool . In terms of its yield of propositions that are informative about a domain, Concept Mapping is at least as efficient as other available KE methods (Otor, 2013). Concept Mapping is likely the most efficient method for generating models of domain knowledge. As a KE procedure, it has been successfully employed to form mediating representations and interfaces for intelligent software (i.e., knowledge-based systems and tutoring systems). Software systems that have been developed using concept mapping and software systems that utilize Concept Maps have generally been based on a satisfying criterion (Bell, 2017).

Evidence of usefulness, usability, performance enhancement or organizational effectiveness is not provided. However, this application of Concept Maps has a clear track record of successful demonstrations in a range of domains (Novak, 2010a). Further research was needed to demonstrate usefulness, usability, and net performance gain using Concept Map-based knowledge acquisition or Concept Map-based intelligent systems. Recognition that the aggregate knowledge of an organization is a valuable asset that must be protected, maintained and augmented, has created a rapidly escalating interest in knowledge elicitation and representation, facilitation of brainstorming techniques through concise, graphical representations of knowledge (Novak, 2010b).

The literature suggests that a variety of representation schemes are needed to capture the full gamut from conceptual knowledge to procedural knowledge. Clearly, it is important to choose “the right representation for the job,” but for many jobs, Concept Maps quite clearly have a role to play in the form of a simple, intuitive

knowledge representation scheme. The following review narrows down to studies that focused on the effect of concept mapping on the dependent variables of this study (Singh and Moono, 2015; Riga, 2015; Novak, 2011; Bamidele *et al*, 2013).

2.3 Concept Mapping Versus Learners' Self-Efficacy

Research reveals that self-efficacy plays a key role in all aspects of human endeavor (Waaktar, 2013). This section brings into perspective a number of studies that involved concept mapping with respect to self-efficacy.

A recent study by Wilson and Kim, (2016) investigated the effects of concept mapping on mastery goal orientation and academic self-efficacy in a collaborative learning environment. The study employed a randomized controlled pretest-posttest group research design to examine whether learning strategies such as concept mapping can help students with both reading comprehension and intrinsic motivation of wanting to master a task at a high level. A total of 42 fifth grade students at Ilshin Elementary School in South Korea participated in this study. The experimental group, which consisted of 22 participants underwent concept mapping training while the control group, which consisted of 20 participants did not. All students were required to fill out questionnaires based on mastery goals, performance goals and academic self-efficacy.

Their results, which were analyzed using one way ANOVA, indicated that concept mapping did not increase mastery goals and mastery goals had no effect on test scores. In addition, the interaction effect between academic self-efficacy and

condition did not increase mastery goals and had no effect on test scores. The study further reported in their findings that,

“Students who experience anxiety will usually perform not as well because they may question their own abilities and talents. This is important because despite having the intrinsic motivation of wanting to accomplish a task, if it is hindered by anxiety then it could lead to compulsive behavior or panic attacks because of fear, especially in the form of not performing as well. In addition, Bandura (1977) research supports this claim because even though students may have high academic self-efficacy it may not increase mastery goal orientation. The reason for this is because if students are unable to observe other students to see how a task is done first, then it can create a sense of nervousness when it is their turn to perform and the full potential of reading comprehension achievement may be hindered. Students will not have a solid idea of what they need to do despite the desire of wanting to do the task”. (Page 20)

These results were attributed to the reduced number of samples that might have caused a potential source of instability considering the statistical procedure chosen. It is however worth noting that one-way ANOVA may not have been the best statistical tool to use given that the sample had been divided into only two groups. Independent samples t-test should have been used instead, as it is robust for determining significance of differences between two groups, without any chance of committing type one error (Bailey, 2008). The target population is also not stated, which makes it difficult to establish whether the sample used was sufficient to represent the population, or not. The current study addressed this issue by using a sufficient sample, basing on criteria of well-known educational research authorities. The target population was also clearly stated for purposes of verifying whether the sample used met the threshold that has been set by various research authorities.

In Iran, a study by Khajavi and Ketabi, (2012) was done, investigating the influence of concept mapping, on reading comprehension and self-efficacy of intermediate EFL (English as a Foreign Language) students in the country. To fulfill the aims of their study, 60 participants (21 males and 39 females) were selected, whose ages ranged between 19 and 23 years. A randomized pre-test post-test control group design, with a concept mapping group and a traditional method group was employed. Prior to the treatment, both the concept mapping group and the traditional method group were administered pre-tests in reading comprehension and self-efficacy. Eight items in the Motivated Strategies for Learning Questionnaire (MSLQ), which measured self-efficacy, were applied to measure students' self-efficacy beliefs.

The duration of training was ten weeks. At the conclusion of the training, all participants again completed the MSLQ. After controlling the effects of pre-test scores, results of Analysis of Covariance (ANCOVA) revealed that students in the concept mapping group showed greater self-efficacy in reading comprehension than students in the traditional method strategy group. These findings are in agreement with another study, in the same country, by Nobahar, Tabrizi and Shanghaghi, (2013), which investigated the effect of concept mapping on Iranian intermediate EFL learners' self-efficacy and expository writing accuracy. Unlike the previous study however, the writing proficiency test, along with self-efficacy questionnaire was given to a larger sample of 180 learners. Based on the results of the writing test and self-efficacy questionnaire, 60 intermediate homogeneous participants were selected and randomly assigned to two groups of control and experimental. In the course of 22 sessions, regular class times of 15 minutes were devoted to concept

mapping. In each session, participants of both groups were given a writing task besides their course book writing section.

Those in the experimental group were engaged in concept map construction after writing each task and organized their pre-writing activities such as discussion, doing exercises and reflective practices according to their constructed concept maps. A post-test of writing and a self-efficacy questionnaire were administered to all the participants, but unlike the study by Khajavi and Ketabi, paired samples t-test, together with the independent samples t-test were used to answer their research questions. Results of their study showed that concept mapping had a significant effect on self-efficacy and expository writing accuracy, just like the previously mentioned study.

Nbina and Viko, (2010) conducted a study on the effect of instruction in metacognitive self-assessment strategy on senior secondary school students' Chemistry self-efficacy. A non-equivalent control group pretest and posttest design, involving one treatment and one control group was adopted, in which a total of 192 students from Port Harcourt Education zone in Nigeria were used for the study. Instructional software was developed, validated and used for the study. A questionnaire was adopted, validated and used for data collection. Their results suggested that instruction in the metacognitive self-assessment strategy improve the students' Chemistry self-efficacy. These findings are in tandem with the previously mentioned studies.

In the USA, Chularut and DeBacker, (2004) performed a study, which investigated the influence of concept mapping on self-efficacy in students of English as a Second Language (ESL) and the effectiveness of concept mapping, used as a learning strategy with students in ESL classrooms. Seventy-nine ESL students participated in the study, which employed the randomized pretest-posttest control group research design.

Their findings revealed a statistically significant interaction of self-efficacy variables in the concept mapping group, with greater gains from pre-test to post-test than the individual study group. One question that begs from this study however is how randomization was achieved, given the static nature of classes in most countries in the world. One would also want to know whether ethical considerations were made in the course of random sampling of the participants. The current study addressed these pertinent questions by using a different research design, which it is hoped not compromise the ethical issues raised from this American study.

Ferla, Valcke, and Cai, (2009), researchers from Belgium investigated whether academic self-efficacy and academic self-concept represent two conceptually and empirically distinct psychological constructs, when studied within the same domain. A questionnaire was used to collect data on self-efficacy in Mathematics of the participants. The study was based on cognitive theories, whose findings indicated that Mathematics self-efficacy and Mathematics self-concept do indeed represent conceptually and empirically different constructs, even when studied within the same domain. Moreover, students' academic self-concept strongly influences their academic self-efficacy beliefs. Additionally, academic self-concept is a better

predictor and mediator for affective-motivational variables, with academic self-efficacy being the better predictor and mediator of academic achievement.

Interestingly, these findings are in total disharmony with a similar study, which was carried out in Greece, using methodology similar to that of Ferla, Valcke, and Cai, (2009). The latter, which was carried out by Paraskeva, Bouta, and Papagianni, (2008), investigated the relationship between individual characteristics of secondary school teachers and computer self-efficacy, as well as teacher prospects with regard to modern technologies. Their second research question concerned the relationship between self-concept and computer self-efficacy, which ascertained that between the two variables there is no significant correlation. The current study tried to reconcile these two studies.

One major point of convergence in all studies reviewed so far, which focused on the influence of concept mapping on students' self-efficacy is the use of the pretest-posttest quasi-experimental research design. The present study also used this design because experts put, it does not require random sampling of participants, which would otherwise be unethical, given the static nature of classes in Kenyan secondary schools. The present will however control for pretest, which is known to compete in one way or the other, with any intervention to influence the outcome of any study.

2.4 Concept Mapping Versus Learners' Attitudes

The effects of touch technology-based concept mapping on students' learning attitudes were investigated by Hwang, Wu and Kuo, (2013) in Taiwan. Effects of two different touch technology-based concept mapping interaction modes on students' learning attitudes in a natural science course, as well as their degree of acceptance of using concept maps to learn were determined. Ninety two sixth graders were randomly divided into three groups. Experimental group one was taught using the Interactive White Board (IWB) using concept mapping approach, experimental group two learned with the touch screen-based concept mapping approach, while the control group learned with the traditional paper-and-pencil based concept mapping approach. A questionnaire was used to measure students' attitude towards the science courses and students' acceptance of the concept mapping approach. Data was analyzed using paired samples t-test and one way ANOVA. Hwang et al, (2013 noted in their findings as follows;

“It is interesting to find that the average learning attitude rating of the students in Experimental Group Two decreased after the learning activity, although the decrease was not significant. Moreover, the average rating of the control group was significantly decreased. From the interviews, it was found that the students in Experimental Group Two and the control group showed less interest in the learning activity since they spent most of their time developing concept maps (i.e., their learning tasks), while the students in Experimental Group One enjoyed the interactions with the teacher and their peers via the IWB. This finding implies the need to design some interaction or competitive activities in the concept map development tasks” (Page 280)

The experimental results of this study therefore showed that in terms of learning attitudes towards the natural science course and the degree of acceptance of using

concept maps to learn, the students were significantly more positive about the two touch technology-based interaction modes, than they were about the traditional paper-and-pencil mode. It is however questionable why the researchers used the paired samples t-test, given that the samples were not related. Independent samples would have been the most appropriate for such a study that involved two groups in which no participant belonged to more than one group. The possibility of type II error being committed in this study can therefore not be exclusively ruled out.

In Iran, another study was carried out by Soroush and Fatemeh, (2013) to establish the effect of applying concept mapping techniques on EFL learners' attitudes towards using this technique in listening comprehension. Their study involved 146 EFL students at the elementary level of language proficiency, who were selected and randomly assigned to experimental and control groups. In the course of eight sessions, the experimental group went under an intervention of concept mapping, during which concept maps were introduced and the listening paper of the Key English Test, used as practice material. Descriptive statistics and a paired samples t-test were used to analyze the data, just like the study by Hwang *et al*, (2013). The former study established that the two groups were significantly different in their listening comprehension ability. In order to assess their participants' attitudes, before and after treatment, the researchers administered a self-assessment questionnaire to the participants in the experimental group.

The results indicated that using concept mapping strategies significantly improve listening comprehension. Basing on the fact that the participants made this realization indicated to the researchers that using concept mapping strategies raise

learners' awareness regarding their listening, and lead to learner autonomy. While the researcher of the present study agreed with the choice of paired t-test, given that the samples were related, ANCOVA should also have been used so as to ascertain whether pre-testing played a significant part in influencing the results because ANCOVA is robust for taking care of such covariates (Bailey, 2008).

In Kenya, a similar study by Njue, Kamau and Mwanja, (2018) determined the effects of Vee Heuristic Teaching Approach on students' attitudes towards learning Biology. This study was conducted in public secondary schools in Tharaka Nithi County, Kenya. The Solomon Four Group Non Equivalent Control Group Research Design was used to implement the study. Data were collected from 12 schools that were randomly sampled from within the research area. The study sample comprised of 396 Form 2 students from four boys', four girls' and four co-educational secondary schools. A Biology Attitude Questionnaire was developed and used for data collection. The questionnaire was pilot-tested in one boy's, one girl's and one co-educational school in Embu East Sub-county, to ascertain its reliability.

The reliability coefficient was estimated using Cronbach's coefficient alpha. A coefficient value of 0.83 was obtained from the research instruments. Hypotheses were tested using ANOVA, and t-test statistics at $\alpha = 0.05$ level of significance. Means were separated using Least Significant. The study found that Vee Heuristics Teaching Approach (VHTA) facilitated students' attitude in biology subject. Since VHTA benefited students irrespective of gender and type of school attended, education authorities should encourage biology teachers, curriculum developers,

quality assurance and standards officers and teacher trainers to apply it in the pursuit of teaching endeavors.

A Nigerian study by Bamidele, Adetunji, Awodele and Irinoye, (2013) examined the effect of Concept mapping learning strategies on the learning outcomes of students in Chemistry. This study compared the effectiveness of the use of different concept mapping strategies (hierarchical, flowchart and spider) as advance organizers on students' performance and also examined the attitudes of students towards the use of the concept mapping strategies in teaching the mole concept in Chemistry, among secondary schools. The study adopted the pretest-posttest control group quasi experimental design.

The population for their study was senior secondary school students in Ife central local government area of Osun state, Nigeria. Chemistry students in their intact classes, in three randomly selected senior public secondary schools in the local government area were used for the study. A total of 132 Chemistry students formed the study's sample, whose ages ranged from 13 to 17 years. The three schools, which were all coeducational were selected and randomly assigned to the treatment groups. A questionnaire consisting of 10 items was used to capture the attitude of their students towards concept mapping strategy in learning Chemistry.

The supplementary instructional package was the use of three types of concept maps (hierarchical, flowchart and spider), presented to the students as advance organizers. Results indicated no significant difference in the students' attitude to the concept mapping strategies, which led to the conclusion that the various types of concept

maps used in the study were effective, and therefore students had similar attitude towards the maps. A question that emerges from this study is whether the 10 items used in the questionnaire were enough to capture accurately students' attitude towards Chemistry. If so, the researchers ought to have explained how the instruments were validated. The present study addressed this issue by adapting questionnaires that have already been tried and tested, then assessed their face and content validity before using them in the current study. This, it is hoped, leads to more credible findings.

Unlike all the previously mentioned studies, a study in by Karakuyu, (2010), investigated the effect of students' concept mapping on their attitude towards Physics lessons. Participants of this study were 58 ninth grade students from two classes, enrolled to a general Physics course in a Turkish high school. One of the classes was randomly chosen as the experimental group, with 28 students, constructed electricity concept maps while the other was control, with 30 students, who did not receive any presentation on concept mapping. Data were collected via the pre- and post-administration of the Concept Maps Attitude Scale Towards Physics (CMASTP) questionnaire.

The study was conducted in six weeks, in a class that met two times a week. The material covered was about electricity. Results showed that while there were no significant differences in attitude between the experimental and control groups, the experimental group students were observed to have a tendency of more positive attitude than the control group students.

In Iran, (Khoshsima, Saed and Hamimzadu, (2016) investigated the effects of concept mapping strategy on Iranian EFL learners' attitude in vocabulary learning. In addition, along with various debates related to gender-based differences on learners' performance in language learning, the study attempted to explore and compare the effectiveness of concept mapping strategy on vocabulary learning outcomes of male and female learners. For these aims, 40 male and female Iranian EFL learners from different majors of Chabahar Maritime University were participated in the study and randomly divided into two groups of control and experimental.

Although the test of proficiency was conducted to the learners, before the treatment the researcher preferred to check learner's homogeneity by Nelson English Language Proficiency Test. Then, the students in the experimental group were taught through concept mapping instruction. After the treatment, attitude questionnaires were administered to the experimental group. In addition, a number of semi-structured interviews were conducted to validate the outcomes of attitude questionnaire. Finally, the obtained data revealed EFL learner's improvement in learning and retention of vocabularies through adopting the concept mapping strategy that significantly has effect on learner's attitude toward vocabulary learning. In addition, exploring the gender difference showed no significant difference between vocabulary learning outcomes of male and female learners (sig= 0.080, $p>0.05$).

In the USA, a study was done by Markow and Lonning, (1998) on the usefulness of concept maps in college Chemistry laboratories and the students' attitudes. The study was conducted using 32 non-science majors enrolled in a first-year Chemistry

course. The experimental group constructed pre-lab and post-lab concept maps, while the control group wrote essays explaining the conceptual Chemistry of the four experiments used in that study. Five students were interviewed to investigate their attitudes regarding the usefulness of concept maps in Chemistry laboratories. The students responded very positively toward the use of concepts maps in the laboratory and strongly felt that constructing pre-lab and post-lab concept maps helped them understand the conceptual Chemistry of the experiments.

It is of interest to the researcher of the current study how and why only five students were used to represent the target population. Was this sample size sufficient to generalize research findings to the target population? External validity is also questionable. The current study tried to address this concern by using a sample that met the threshold set by well-known experts in educational research. By clearly defining the population and sample size and sampling procedures as was done in the current study, it was easy to verify whether or not findings of this study could be generalized to the target population.

One major similarity in all studies reviewed that investigated the effect of concept mapping on students' attitude in various subjects is the use of quasi-experimental research design. The present study also used this design because it does not require random sampling of participants as required in experimental studies, which would otherwise have been unethical to do so, given the static nature of classes in most Kenyan secondary schools.

2.5 Concept Mapping Versus Learners' Motivation

Research shows that motivation in education can have several effects on how students learn and how they behave towards subject matter. It can (i) direct behavior towards particular goals, (ii) lead to increased effort and energy, (iii) increase initiation of, and persistence in activities, (iv) enhance cognitive processing, (v) determine what consequences are reinforcing and (vi), lead to improved performance (Piers, 2012). This section therefore looks at what previous studies have found, out regarding how the use of concept mapping as an instructional strategy affects motivation of the learner.

In Kenya, a study was done by Shihusa and Keraro, (2009) to investigate the effect of using advance organizers on students' motivation to learn Biology. The research design used was quasi-experimental, where the nonrandomized Solomon Four group was adopted. The focus was on the topic "pollution". Their sample comprised of 166 form three students in Bureti District (current Bureti sub county). Data were collected using a questionnaire. A t-test, one-way ANOVA and ANCOVA statistical techniques were used to analyze the data, whose findings indicated that students taught using advance organizers had a higher level of motivation than those taught using conventional teaching methods.

The findings further revealed that following the intervention, male students had a significantly higher level of motivation than their female counterparts. These results are a sharp contrast to those of another study, which was done in the USA, by Jones, Ruyf, Snyder, Petrich and Koonce, (2012) on the effects of mind mapping activities on students' motivation. The latter examined how students' motivation differed

when they participated in three different types of mind mapping activities: one activity that was completed individually outside of class time, one that was completed individually in class with the instructor available for help, and one that was completed in class with other students and the instructor available for help.

Using the MUSIC Model of Academic Motivation (Jones, 2009) as a framework, Jones and his friends implemented a concurrent mixed methods design, using identical samples, whereby the quantitative component was dominant over the qualitative component. Participants included 40 undergraduate students enrolled in an educational psychology course at an American university. After each of the mind mapping activities, study participants completed questionnaires that included open- and close-ended items. Although the three activities had similar effects on students' motivation-related beliefs, some differences were documented in their preferences of mind mapping activities.

Chion, (2015) conducted a study that compared the effect of different concept mapping on students' learning motivation and academic achievement. In his study, a pretest-posttest control group experimental design was employed. The participants were 151 students from the Department of Accounting Information at a private university in central Taiwan, who were taking an advanced accounting course. An effect size and analysis of covariance (ANCOVA) were used to analyze experimental results. Experimental results showed that the two computer-assisted concept mapping techniques (construct-on-scaffold and construct-by-self) were more beneficial to students' learning motivation than the traditional paper-and-pencil concept mapping and textbook exercise methods. In addition, the traditional

paper-and-pencil concept mapping was found to be much better than the textbook exercises method. However, no significant differences were found to exist between the two computer-assisted concept mapping techniques.

In Bulgaria, a study was done by Kostova and Radoynovska, (2010) on motivating students' learning using word association test and concept maps. In their work, the free word association test was used for revealing the scientific conceptual structures of 8th and 12th grade students, around a stimulus word "human being" and for motivating them to study human Biology. The stimulus word retrieved a cluster of associations, most of which were based on science education and experience. Associations with the stimulus word were analyzed and classified according to predetermined criteria and structured by means of a concept map. The stimulus word 'human being' was quantitatively assessed in order to find out the balance between the associations with its different aspects.

On the basis of their results some connections between Biology and other sciences studying the human being, were worked out. Each new topic in human Biology was studied by using content analysis of the textbook and concept mapping as study tools and thus maintaining students' motivation. The obtained data was also valuable in clarifying the complex nature of human beings, and confirming the statement that Biology cannot answer all questions concerning human nature. Inferences were made about the word association test combined with content analysis and concept map construction as an educational strategy.

The effects of experiential cooperative concept mapping instructional approach on secondary school students' motivation in Physics were investigated in Kenya by Wambugu *et al*, (2014). Their study adopted the Solomon four non-equivalent control group design, under the quasi- experimental research. A stratified random sample of 12 Secondary Schools was drawn from Nyeri County. Four boys' alone, four girls' alone and four co-educational schools were randomly assigned to four groups with a total of 513 form two students. Students in all the groups were taught the same Physics content of Magnetic Effect of Electric Current.

The experimental groups were taught using concept mapping approach while the control groups were taught through regular teaching methods. Two groups were pre-tested prior to the implementation of treatment. After five weeks, all four groups were post-tested using the Student Motivation Questionnaire (SMQ). The instrument was validated and pilot tested before use. The reliability coefficient for SMQ was 0.81. The instrument was scored and data analyzed using t-test, one-way ANOVA and ANCOVA at a significance level of alpha equal to 0.05. The results of the study revealed that there was a statistically significant difference between the motivation to learn of students who were taught through concept mapping and those taught through the regular methods.

A question that begs from this study is how and why inferential tests were used to analyze data collected from a questionnaire, which was presumably qualitative. The researchers should have come out clearly to explain this because parametric tests, especially ANOVA, ANCOVA and t-test, which were all used in this study, are very sensitive to their assumptions, which if a researcher is not keen to assess them

beforehand, may unknowingly commit of type I error, which is a very serious error in research as it implies the findings were not very credible.

A Greek study by Riga, (2015) investigated if there is a positive effect of the use of concept mapping software on students with Attention Deficit (AD) when learning descriptive writing in the secondary level of education. He also examined what kind of difficulties AD students may have come across during this learning procedure. Sample students were selected and assessed in their use of a combination of distinct educational tools, namely a questionnaire for teachers following the Greek Evaluation Scale, the Stroop Test and the Trail Making Test. Results confirmed that the majority of the students believe they learn better when using computers and that particularly the concept mapping software presents the subject matter in an easier, more interesting and pleasant way, despite some difficulties throughout the learning procedure.

2.6 Concept Mapping Versus Learners' Academic Achievement

Achievement is learners' level of successful understanding of concepts taught or learnt (Masinde *et al*, 2015). High academic achievement is the wish of all stakeholders in the education sector and hence research on any factor that affects students' achievement in any way is obviously of interest to educational stakeholders. This section reviews studies that looked at concept mapping versus academic achievement.

One of the objectives in the previously mentioned study by Wilson and Kim, (2016) was to find out the effect of concept mapping on students' academic achievement. Their quasi-experimental study was informed by the fact that students with weak or no learning strategies may not be as successful as their higher performing peers. An achievement test on several skills in English was used to collect data before and after intervention.

Data was analyzed by regression analysis, whose results supported the study's alternative hypothesis that concept mapping is a significant predictor of students' mastery of English reading and comprehension. Further analysis of the collected data, using one-way ANOVA showed that the model used significantly explained 66% variance of the dependent variable, which was achievement in English. A major factor that impresses the researcher of the current study is that all major assumptions of parametric tests used in this study were assessed beforehand and the test consequently found suitable for analyzing the research data, meaning that these findings are highly credible. The present study has done the same, so as to minimize chances of committing statistical errors.

Cheema and Mirza, (2013) investigated the effect of concept mapping on academic achievement of 7th grade students in the subject of general science. Their quasi experimental research was based on a 2x2 factorial research design, involving 167 students, selected from two single sex schools. Major objectives of the study were to; (i) find out the effect of concept mapping as a learning strategy on the academic achievement of students (ii) study the differential effect of concept mapping on academic achievement of male and female students (iii) to find out the interaction

effect of concept mapping as a learning strategy and gender on students' academic achievement.

The researchers developed their own achievement tests and administered them to students before and after intervention. During the treatment, which lasted five months, the experimental group was trained to develop concept maps for three weeks. Subsequently students developed concept maps of general science content individually, shared them in groups and were compared by teacher with scientifically accepted concept maps for possible correction and improvement. Data on gain achievement scores were analyzed through two-way ANOVA. Results showed that the male and female students taught through concept mapping performed better than the students who were taught through traditional teaching methods.

However male students taught through concept mapping performed significantly better than the female students. One serious issue that was of concern to the researcher of the current study is the duration of the study, which was a whopping five months! This time frame might have been rather too long, which could have given maturation a chance to negatively affect internal validity of the study in question. The current study rectified this by limiting the teaching of electrochemistry to a maximum duration of three weeks, as stipulated by the syllabus.

In Lebanon, a study was done by Boujaoude and Attieh, (2008), on the effect of using concept maps as study tools on achievement in Chemistry. Their objectives were to: (1) examine whether or not the construction of concept maps by students

improves their achievement and ability to solve higher order questions in Chemistry, (2) investigate the differential effect of the treatment by gender and achievement level, and (3) explore the relationships between performance on concept maps and Chemistry achievement. Participants of this study were 60 tenth-grade students, who were randomly divided into two groups: - experimental and control.

The study spanned six weeks, in a class that met five times a week. The material covered was acid-base titration and equilibrium in weak acids. The students were pre- and post-tested using a teacher-constructed Chemistry test. Results showed that while there were no significant differences on the achievement total score, there were significant differences favoring the experimental group, for scores on the knowledge level questions. Moreover, there were gender-achievement interactions at the knowledge and comprehension level questions, favoring female students and achievement level achievement interactions favoring low achievers. Finally, there were significant correlations between students' scores on high level questions and total concept map scores. This study informed the current one in the sense that achievement was chosen as one of the dependent variables investigated.

A Nigerian study by Otor, (2013) focused on the effects of concept mapping strategy on students' achievement in difficult Chemistry concepts. It also examined the differential effect on the achievement of male and female Chemistry students. Two research questions and two hypotheses were formulated to guide the research. His study used a quasi-experimental pretest-posttest group research design. Data were collected from 1,357 Chemistry students, using a stratified random sampling procedure, from two schools in two local government Areas of Benue State of

Nigeria. One instrument for data collection was developed by the researcher and validated by experts - the Chemistry Achievement Test, on Structure of Matter and Energy Changes.

The research questions were answered using mean and standard deviation scores, while the hypotheses were tested at the 0.05 significance level, using ANCOVA. Students taught using concept mapping strategy achieved higher and significantly better scores than those taught using conventional metacognitive methods. There was also a better performance in favor of female students as compared to their male counterparts using this method.

The study recommended among other things, adequate training of Chemistry teachers on the use of concept mapping strategy in teaching Chemistry at the secondary school level. A major strength of this study was the choice of ANCOVA for testing the null hypotheses. Being robust for controlling the extraneous effect of pretest on the outcome, the findings from ANCOVA must have had high internal validity. It is on this basis, coupled by evidence from other scholarly sources that the same inferential test was used to test a similar hypothesis in the present study.

A more recent study by Singh and Moono, (2015) investigated the effect of using concept maps on *Zambian* students' achievement in selected Chemistry topics at tertiary level. Three groups were used in this study, one control and two experimental. The pretest-posttest true experimental research design was adopted, using 39 first year students at Mafulira College of Education. All the groups were randomly assigned into their respective groups, each with 13 students. Treatment

lasted four weeks using the topic “atomic structure” and chemical bonding. Whereas the control group used traditional methods of instruction, experimental group 1 used the concept map method while experimental group 2 used both methods. One-way ANOVA at the 0.05 alpha level was conducted to analyze the pretest and post test scores.

Results revealed no significant differences in the pretest mean scores but significant ones in the post test. Post hoc comparisons indicated that both experimental groups were similar, but different from the control group. These findings supported the study’s alternative hypothesis that when students are taught using both traditional and concept mapping approaches, they achieve the best scores. It is on the basis of these findings that the current study used a combination of both traditional and concept mapping strategies, so as to achieve the hypothesized outcomes in the experimental groups of the present study and hopefully solve the problem that necessitated the study.

In Singapore, a study was done by Chee and Wong, (1996) on the effects of incorporating concept mapping into computer-assisted instruction. Their study was carried out to determine the effects of incorporating concept mapping into computer-assisted instruction. There were 37 boys and 54 girls from a Special Assistance Plan school, who participated in their study. The students received computer-assisted instruction on the topic “Organic Chemistry” for 7.5 hours. They were randomly assigned to three different groups. In the Partial Map group, the students were given partial concept maps in the program and assigned the task of constructing one complete concept map after each topic.

In the Complete Map group, the students were provided with complete concept maps and performed note-taking activities during the lessons. In the Menu-selection group, students used traditional menu-selection system and also performed note-taking activities. An Achievement Test was then administered to determine the students' achievement, after being taught using concept mapping. ANCOVA, with Chemistry mid-year results as covariate was performed.

There was a significant difference in performance in their Chemistry Achievement Test, among the three groups of students. The least squares means for the achievement test score of the three groups were computed and compared. The questions were classified into Low and High order questions, and ANCOVA was again used to test for any significant differences in results among the three groups of students. A significant difference was found on the performance in Chemistry Achievement Test among the three groups of students. The Partial map group performed significantly better than the other two groups but there was no significant difference between the Complete Map group and the Menu-selection group. The researchers noted in their work,

“Students generally showed favorable attitudes towards chemistry and towards CAI but no significant difference in attitudes towards chemistry and towards CAI were found among the three groups of students. It could also be due to the short treatment period since change of attitudes is unlikely to be effected over such a short period of time. However, there was some indication that concept mapping activities had an influence on the student's affective outcome. Many students in the Partial Map group requested to keep their concept maps after the treatment but no students from the other two groups had requested to keep their notes. Students in the Partial Map group claimed that they had put in a lot of effort in drawing the concept maps and they felt a strong sense of ownership of these maps. Many of them also felt that the concept maps could help them in the learning of the topic, organic chemistry, which was to be introduced in the formal curriculum some time after the study.” (Page 8)

Data collected by Chee and Wong, (1996) showed that students in the partial map group performed significantly better than students in the other two groups in High Order questions but not in Low Order. An issue of concern to the researcher of the present study is why the middle level questions were left out, yet they are known to play a vital role in the cognitive development of learners (Fredericks, 2005). It is for this reason that in the current study, as will be seen in the next chapter, that achievement tests were constructed basing on all six levels in the Bloom's taxonomy of instructional objectives.

2.7 Concept Mapping Versus Learners' Use of Experimental Skills

Experimental skills are scientific skills that one utilizes using their sense organs in order to solve a practical problem e.g. measuring, titrating etc. Interestingly, it was not until recently that a few researchers developed interest in concept mapping with respect to learners' exploitation of experimental skills. One study is by Zadeh, Gandomani, Deleram and Yekta, (2015) compared the effect of concept mapping and conventional methods on nursing students' practical skill score.

Their quasi-experimental study was conducted on 70 nursing students, randomly assigned into two groups of 35 people. The intervention group was taught through concept mapping method, while the control group was taught using conventional method. A two-part instrument was used, including a demographic information form and a checklist for direct observation of procedural skills. Descriptive statistics, chi-square, independent samples t-tests and paired t-test were used to analyze data. Results of their study revealed that before education, no significant differences were observed between the two groups in the three skills of cleaning ($p = .251$), injection ($p = .185$) and sterilizing ($p = .568$).

The students mean scores were significantly increased after the education and the difference between pre- and post-intervention of students mean scores were significant in the both groups ($p < .001$). However, after education, in all three skills the mean scores of the intervention group were significantly higher than the control group ($p < .001$). The conclusion made was that concept mapping is superior to conventional skill teaching methods. These findings are in unison with those of an older study by Ogundola, Abiodun and Oke, (2010).

Ogundola *et al*, (2010) assessed the effect of constructivism instructional approach on teaching practical skills to mechanical related trade students in western Nigeria technical colleges. Elements of constructivism assessed were; concept mapping, cooperative work skills and cognitive apprenticeship. Pretest, posttest experimental design with a non-equivalent control group was adopted for the study. A total of 106 randomly selected year two students in mechanical related trades were drawn from four technical colleges spread across the south western Nigeria States. Forty six of

these numbers were placed in the experimental group while sixty were placed in the control group.

The research instruments developed, validated and used for data collection were the constructivism lesson plan, conventional lesson plan and the General Metal Work Achievement Test (GMWAT). The GMWAT, which was a 30 item objective questions with four options, was administered to all the groups before and after the experiment. Three research questions were raised while two hypotheses tested at 0.05 level of significance were used for the study. Frequency counts, mean and standard deviation were employed to answer the research questions while t-test and ANCOVA were used to test the hypotheses.

Their results showed a significant difference between the students taught with constructivism teaching approach and those in the control group. There was no significant difference between male and female students exposed to the constructivism approach. A point of concern is how random sampling was made possible in this study given that it was a true experimental study, which demands that all participants be selected on random basis. It is also interesting that these two studies, which were grounded on two very distinct theoretical backgrounds, yielded identical results. Another point of concern is that there is no other study known to the researcher of the current study, which has investigated concept mapping versus experimental skills. Findings of this study therefore go a long way in enriching literature for further review by other researchers.

2.8 Concept Mapping Versus Meaningful Learning Theory

The Concept map is a tool that science teachers can use to determine the nature of students; existing ideas (Novak, 2010b). The map can be used to make evident the key concepts to be learned and suggest linkages between the new information learnt and what a student already knows. Concept maps can precede instruction, and be used by the teacher to generate a meaningful discussion of students' ideas. Following the initial construction and discussion of concept maps, instructional activities can be designed to explore alternative frameworks, resulting in cognitive accommodation.

It is on the basis of these arguments that concept maps were used by teachers in the experimental groups of this study at the beginning of every lesson in the topic of electrochemistry, to serve as advance organizers. The teachers then used conventional instructional strategies to teach the rest of the content, but at the end of every lesson, students were asked to draw concept maps linking all concepts that had been taught in the topic hitherto. At the tail end of the topic, learners used concept maps for revision, instead of their exercise or books, which would have culminated into rote learning, since knowledge acquired this way could not be represented graphically, unlike in concept mapping groups where retrieval was relatively easier and faster.

Trifone, (2006) investigated concept mapping as a learning strategy to motivate 82 high-ability 10th-grade students to take a more meaningful approach to learning biology. The study employed a quasi-experimental, pretest-posttest mixed methodology design to assess the relationship between concept-mapping proficiency

and changes in motivational and learning strategies use profiles using the Motivated Strategies for Learning Questionnaire (MSLQ). The qualitative and quantitative findings of the study suggested a mixed motivational response by learners in taking a more meaningful approach to learning Biology using concept mapping. Specifically, the findings revealed that concept mapping may play a supportive role in contributing to a more meaningful approach to learning Biology, as indicated by positive and statistically significant effects on students' test performance, as well as adaptive and statistically significant fall-to-spring changes in motivational and learning strategy use profiles in direct relation to the level of mapping proficiency.

This dichotomous relationship appeared to be a consequence of whether learners' perceived that concept mapping could provide them with a more effective learning strategy than those utilized in the past and, more importantly, upon their willingness to put in the requisite time and effort to develop proficiency in using mapping to take a more self-regulated and meaningful approach to their learning. The study consequently noted that it behooves the educator interested in using concept mapping to consider students' receptiveness to using concept mapping and encourage them to perceive the value of becoming sufficiently proficient in its use for instructional purposes (Trifone, 2006).

2.9 Gaps in Literature Review

It is apparent from review of related literature that concept mapping has been and is still an area of great interest to many educational researchers in different subject areas. However in as much as many aspects of learning have been addressed extensively, many gaps still exist, some of which this study hopes to fill. One major

gap in this Literature review is that most of the prior studies dealt with ‘analogue’ concept mapping, where concept maps were initiated by students themselves and drawn on paper. However, this study went ‘digital’ by using the latest versions of concept mapping software, so as to keep up with the fast changing world of technology.

Secondly, no study known to the researcher hitherto had investigated whether students’ attitude and experimental skills could interact to influence academic achievement when concept mapping is used as a metacognitive strategy. It is on this basis that the researcher of the present study came up with objective number (iii), so as to provide knowledge that has hopefully filled or narrowed this gap. Third, no study known to the researcher hitherto, had been conducted to investigate whether students’ experimental skills, self-efficacy and attitude could predict their achievement in electrochemistry on using SOCM as a metacognitive strategy.

The fourth objective of this study was specifically drafted with the intention of providing knowledge that hopefully fills this gap. Fourth, there was no study known to the researcher hitherto, which had investigated whether students’ achievement in electrochemistry differed by gender and school type, with SOCM used as an instructional strategy. Findings from the fifth objective of this study do provide some knowledge that fills this gap. Lastly, there was no study known to the researcher hitherto, which had investigated SOCM or any other form of concept mapping as a metacognitive learning strategy in electrochemistry or any other topic in Chemistry, in Kakamega County or anywhere else in Kenya. This study is therefore considered a ‘pioneer study’ which gives insight to other researchers who

are interested in novel instructional strategies of improving academic performance in the country.

CHAPTER THREE:

RESEARCH METHODOLOGY

3.1 Main Highlights of Chapter Three

This chapter highlights on the research design that was used, where the study was carried out from, the target population, sample size, sampling procedures, research instruments, piloting, data collection and analysis procedures and finally, the ethical considerations that were made.

3.2 Research Design

By combining qualitative and quantitative research methods, the weaknesses of one method can always be taken care of by strengths of the other. This is according to Creswell and Plano, (2011) who explained:

“A problem exists when the quantitative results are inadequate to provide explanations of outcomes, and the problem can best be understood by using qualitative data to enrich and explain the quantitative results in the words of the participants. In other words, mixed methods research helps answer questions that cannot be answered using only qualitative or quantitative methods alone. Mixed methods provide a more complete picture by noting trends and generalizations, as well as in-depth knowledge of participants’ perspectives.” (Page 33)

For this reason, a mixed methods approach was used in this study to obtain both quantitative and qualitative findings. Research data were collected sequentially, because this approach demands integration of the data in one or more stages of a research process (Guest, 2013). In this regard, quantitative data were collected first, followed by qualitative data in quick succession. Quantitative data provided the study’s primary findings, which were corroborated by the qualitative findings. The

qualitative phase of the study was accomplished through Focus Group Interviews (FGI), which were conducted immediately after the last stage of the quantitative phase, on some of the students who participated in the study to capture their views about several aspects of learning namely; self-efficacy beliefs, attitude and motivation in Chemistry. The quantitative phase was implemented through quasi-experimental research design, using non-randomized pretest-posttest with control group being a model as shown in Figure 3.1.

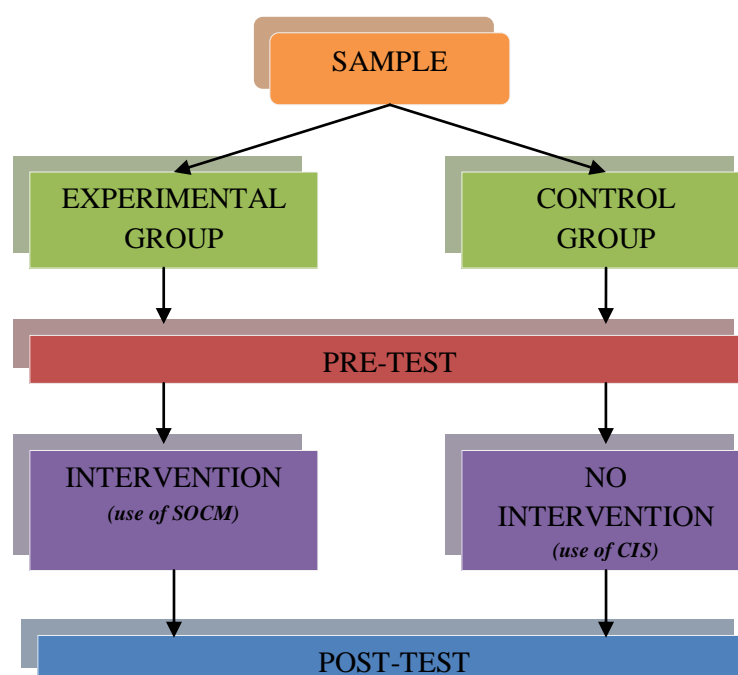

Figure 3.1: Model showing how the Quasi-Experiment was done

Adapted from Shadish, Cook and Campbell, (2002)

It can be seen as illustrated in Figure 3.1, that this research design was implemented by assigning the sample into two treatment groups; one experimental and one control. Both groups were pre-tested, after which the experimental group received intervention as the control group maintained status quo. Intervention entailed the use

of SOCM by Chemistry teachers assigned to experimental groups for teaching the whole topic of electrochemistry. It also included students' use of the concept maps drawn on their own or with the help from their teachers, to revise electrochemistry during their private study sessions. While this was happening, Figure 3.1 further tells us that students in the control groups were also taught the same topic of electrochemistry, albeit using the Conventional Instructional Strategies (CIS). Both treatment groups were thereafter post-tested as Figure 3.1 further illustrates.

Pre-test served the purpose of establishing whether or not the sampled students had the same entry behavior in terms of the study's dependent variables, without which a study is deemed to lack internal validity (George and Mallery, 2003). Posttest on the other hand was used to compare the treatment groups, with respect to the study's dependent variables, so as to establish whether or not the intervention given to students in the experimental groups made a difference. Comparison of the experimental groups versus the control groups therefore climaxed the quasi experiment.

This research design was deemed most appropriate for this study because; (i) it involves control groups, which enhance a study's internal validity, (ii) it involves pre-testing, which allows the researcher to establish beforehand whether or not the sample selected is homogenous, a crucial requirement for inferential analysis, especially when using parametric tests (DeRue, 2012). Potential threats of this research design to internal and external validity were; interaction, multiple treatment effect and maturation. These threats were however countered or minimized by; (i) random assignment of intact classes into experimental and control groups, (ii) using

different schools as experimental and control groups, and (iii), administering posttest shortly after intervention.

The qualitative phase of this study was carried out after the quantitative phase as previously mentioned, whereby oral interviews were conducted on several focus groups of students who had taken part in the quantitative phase of the study, to gather information that corroborated the quantitative research findings. Details of how the focus groups were arrived at are elaborated in section 3.6 of this chapter.

3.3 Location of the Study

The study was carried out in Kakamega County, Kenya. This region was opted for by the researcher, reason being that of all counties in western Kenya, the county stood out as the one with the highest number of schools that offer computer studies, and consequently had the highest computer-student ratio, which in turn provided a wide range of sampling options. Results of this study therefore have high external validity. Table 3.1 gives the number of schools in the former western province, and their relevant statistics.

Table 3.1: Computer Statistics of Western Kenya's Secondary Schools

County	Total no. of Schools	Avg. no. of Students per class	Avg. no. of Computers per school	Avg. Computer /Student Ratio
BUSIA	385	38	12	1:3.2
BUNGOMA	392	42	16	1:2.6
KAKAMEGA	411	40	20	1:2.0
VIHIGA	303	35	10	1:3.5

Source: Busia, Bungoma, Kakamega, Vihiga CDE Offices, 2015-2016

Kakamega County is situated in western Kenya. Kakamega town is the headquarters of this county, which is bordered by; Busia, Bungoma, Siaya, Vihiga, Nandi, Uasin gishu and Trans Nzoia counties. It occupies a geographical area of 3,050.3 km² and has a large population of 1,660,651 persons, the second highest in Kenya. The county has 12 sub-counties namely; Likuyani, Lugari, Matete, Kakamega North, Kakamega East, Kakamega South, Kakamega Central, Kwisero, Butere, Mumias, Matungu and Navakholo.

Kakamega county has 411 secondary schools, 282 of which are mixed, 73 girls' and 56 boys' schools. The secondary school population is 113, 202 students and 3,620 teachers, which is a teacher-student ratio of 1:31. The secondary school enrolment rate is 69%, while the dropout rate stands at 9.5 %. Most schools in this region perform dismally in Chemistry during national examinations as revealed by previous KCSE analysis reports. (Source: KNBS, CDE and CDO Offices).

3.4 Target Population

Out of the 411 secondary schools in Kakamega County, the study targeted the 4,000 form four students in all the secondary schools (Appendix 17) that offer computer studies as an examinable subject and had computer laboratories. Only form four students were targeted in this study, because the topic of interest, which was Electrochemistry, is taught at this level in the current syllabus.

3.5 Sample Size

The sample size of this study was determined using the formula of Krejcie and Morgan, shown in Figure 3.2

$$S = \frac{x^2 NP(1 - P)}{d^2(N - 1) + x^2 P(1 - P)}$$

Where: **S** = required sample size
X = z-value, 1.96 at 0.05 alpha
N = population size
P = population proportion (assumed to be .50 since this provides maximum sample size)
d = degree of accuracy expressed as a proportion (.05)

Figure 3.2: Formula that was used to calculate the study's sample size
Source: Delice, (2010)

Taking 4000, which is the study's target population, as the value of N in the formula, 350 was obtained as the calculated value of s, the sample size that was deemed sufficient to represent the study's population. A value equal to or greater than this should therefore have sufficed for generalizing the research findings to the entire population (Wilcox, 2010). The study used 400 students, which was even bigger than the calculated sample size value.

3.6 Sampling Procedures

Multi-stage sampling technique was used to arrive at the required sample as shown in Table 3.2, which gives a brief summary of the main procedures that were involved.

Table 3.2: Sampling Frame

Sampling Procedure	Population	Sample
Purposive sampling of schools that offer computer studies/have computer laboratories	411	65
Purposive sampling of schools whose average mean in KCSE for the last 3 years ranges from 5-7	65	25
Proportionate stratified random sampling from the purposively selected school types as the strata	25	10
Simple random sampling of form four students from the 10 schools meeting the previous criteria, by selecting one intact stream in each	4000	400
Purposive sampling of Chemistry teachers who were hitherto teaching the selected form 4 students	30	10

To begin with, purposive sampling as indicated in Table 3.2 was used to select from the accessible population only schools that offer computer studies or those with computer laboratories. This was because the intervention of this study vis-à-vis SOCM, needed computers as an instructional media resource, which compelled the researcher to purposively select these kinds of schools, as they were the only ones in the research location which were equipped with sufficient computers for proper implementation of SOCM.

From the resulting list of schools, purposive sampling was also used to select only schools whose average mean score in KCSE for the last three years was between 5 and 7 points, in an attempt to ensure fair competition and the need for a sample with similar entry behavior. Heterogeneity of participating schools being a mandatory requirement for achieving the fifth objective of this study, this range was deemed most appropriate, as it has been found through research to be the most heterogeneous (Wasike, 2013).

Thereafter, it can be observed from Table 3.2 that proportionate stratified random sampling was used to select schools of each type needed i.e. co-educational, boys' only and girl's only, to ensure fair representation, because school type was one of the factors under investigation. Figure 3.3 shows how the proportions or exact number for each type of school needed were computed;

$$\begin{aligned}
 \text{Mixed Schools Needed} &= \frac{15}{25} \times 10 = 6 \\
 \text{Girls Schools Needed} &= \frac{5}{25} \times 10 = 2 \\
 \text{Boys Schools Needed} &= \frac{5}{25} \times 10 = 2
 \end{aligned}$$

Figure 3.3: Computations of No. of Schools of Each Type Needed

It can be seen from Figure 3.3, that six mixed schools, two girls' schools and two boys' schools were proportionately selected for this study. Each school type was therefore fairly represented using this selection criterion. Simple Random Sampling (SRS) was used to select the specific schools to be used, guided by the computations in Figure 3.3. To select the students for participating in the study, SRS was further

used to select only one of the form four streams in the case of schools with multiple form four streams. For schools with only one form four stream, the entire stream participated in the study.

SRS was executed using the balloting technique, whereby different random numerals were assigned to all schools that were earmarked for participating in the study via the previously mentioned selection criteria. The numerals were written on separate small pieces of paper of same size and color. Each of the papers was then folded to conceal the numbers and placed in 3 different bags, one for mixed schools, another one for girls' schools and the other for boys' schools. All the bags were then closed and thoroughly shaken to mix up their contents.

Since only 10 schools were required, a blindfolded person was asked to pick 10 pieces of paper from the bags as required i.e. 6 from the mixed schools' bag, 2 from the girls' schools bag and 3 from the boys' schools bag. Picking of the pieces of paper was done one at a time without replacement. Schools corresponding to the numbers on the papers that were fished out of the bags were eventually used for the study. The same technique was used to select one form four stream to be used in the study, in the case of schools with multiple form four streams. This technique ensured that all eligible schools and students had an equal chance of being selected to participate in this study.

To take care of interaction, which is a known potential threat to internal validity of a study (Pearl, 2015), different schools were used as experimental and control groups. The 10 intact streams of form four students selected as earlier described were

randomly assigned into two treatment groups and labeled SOCM-1, SOCM-2, SOCM-3, SOCM-4, SOCM-5, CIS-1, CIS-2, CIS-3, CIS-4 and CIS-5. Those with the prefix “SOCM” made up the experimental group while those with the prefix “CIS” formed the control group. These prefixes were used deliberately and strategically so, for ease of identification of each research group by type of treatment it received. This was because SOCM and CIS as used in this document are acronyms for “Software-Oriented Concept Mapping” and “Conventional Instructional Strategies” respectively, which were the two treatments that were under scrutiny.

Purposive sampling technique was finally used to select all the respective Chemistry teachers that were teaching the selected form four students in the selected schools just before this study took off. This was an effort to avoid any timetable issues as a result of random sampling of the teachers, which in turn could have made some schools reluctant to participate in the study. The exact numbers of participants that constituted each research group were as presented in Table 3.3, from which it can be observed that the smallest research group had 35 students, while the biggest had 44 students, each group with one Chemistry teacher.

Table 3.3: Table of Subjects

Group Type	Label	Total No. of Students	No. in Focus Group	No. of Teachers
Experimental	SOCM-1	37	9	1
	SOCM-2	41	7	1
	SOCM-3	44	10	1
	SOCM-4	35	6	1
	SOCM-5	43	8	1
	Sub-total		200	40
Control	CIS-1	40	6	1
	CIS-2	35	7	1
	CIS-3	42	6	1
	CIS-4	41	6	1
	CIS-5	42	8	1
	Sub-total		200	33
Whole Sample	TOTAL	400	73	10

It can also be observed from Table 3.3 that the two treatment groups (experimental and control) were equal in size, as they each had 200 students as respondents. The equal numbers was purely coincidental.

As for the qualitative phase of this study, Table 3.3 further shows us that 10 focus groups, comprising of 73 respondents in total, were involved in the interviews, one group from each of the 10 that had participated in the quantitative phase of the study. Additionally, the participants of the FGI therefore formed sub-samples of between 6 and 10 students in each focus group to represent their respective research groups. Selection of these respondents was on volunteer basis, which explains why the focus groups were of different sizes. Each FGI was moderated by one Chemistry teacher as Table 3.3 informs us.

3.7 Research Instruments

After comprehensive literature review and consultation with several educational research experts, and guided by the five research objectives, the researcher developed six instruments for data collection. These included; an observation check list, two questionnaires, one interview guide and two achievement tests. Details of each instrument are discussed in the subsequent subsections.

3.7.1 Students' Self-Efficacy Questionnaire (SSEQ)

The Students' Self-Efficacy Questionnaire, SSEQ (Appendix 5) was a close ended questionnaire, which sought information about students' self-efficacy in the use of the two instructional strategies under investigation, Chemistry lessons, Chemistry assignments and Chemistry in general. It was adapted and modified from Aurah, (2013), who used it to measure students' self-efficacy beliefs in Biology. The instrument was administered before and after intervention to all the sampled form four students, to collect data that was used to address the second and fourth objectives of this study.

The SSEQ had two parts; Part A, for capturing the relevant students' demographics, and part B, which comprised of 22 close-ended statements on a five point Likert-type scale. Some of the statements therein were positively worded while others were negatively worded. Positively worded statements were scored as follows; Strongly Agree = 5, Agree = 4, Undecided = 3, Disagree = 2 and Strongly Disagree = 1. Negatively worded statements were on the other hand scored in the reverse order i.e. Strongly Agree = 1, Agree = 2, Undecided = 3, Disagree = 4 and Strongly Disagree

= 5. A composite score for all the statements in the SSEQ was determined and converted into percentage by dividing it by 110, the maximum possible composite score and multiplying the quotient by 100.

A students' maximum possible score was therefore 100% (for the one who scored 5 in each of the 22 statements) while the minimum possible score was 20% (for a student who scored 1 in each of the statements). To enhance its completion rate, the researcher produced colored copies of the SSEQ. To ensure a high return rate, the students were sensitized prior to filling the SSEQ about a hitherto unspecified nonmonetary incentive (Appendix 23), which was given to those who returned their fully filled questionnaires.

3.7.2 Students' Attitude and Motivation Questionnaire (SAMQ)

The SAMQ (Appendix 6) measured students' attitude and motivation in Chemistry before and after intervention. The two variables were measured in the same instrument albeit in separate sections, due to the relatively high number of instruments that had to be administered to the same subjects in this study.

The SAMQ consisted of three parts; Part A was for capturing the relevant students' details while part B was for measuring students' attitude. This part comprised of 22 close-ended items on a five point Likert-type scale. Some of the statements were positively worded while others were negatively worded, but all seeking information about students' attitude towards Chemistry lessons, Chemistry assignments and the subject in general.

Part C on the other hand was for measuring students' motivation in Chemistry before and after intervention. This part comprised of 12 items, some positively worded and others negatively worded, all of which were designed basing on some of the Keller's, (2010) motivational variables namely; attention (extent to which the students felt Chemistry aroused their attention in class), relevance (extent to which the students found Chemistry content important for their future endeavors), confidence (extent to which Chemistry content boosted their confidence in performing well academically) and satisfaction (extent to which students felt knowledge of Chemistry would satisfy their future needs).

Positively worded statements in the SAMQ were scored in descending order i.e. Strongly Agree=5, Agree=4, Undecided=3, Disagree=2 and Strongly Disagree=1 while negatively worded statements were scored in the reverse order i.e. Strongly Agree=1, Agree=2, Undecided=3, Disagree=4 and Strongly Disagree=5. A composite score for all the statements in the SAMQ was determined and converted into percentage. A students' maximum possible score was therefore 100% (for the one who scored 5 in each of the statements) while the minimum possible score was 20% (for a student who scored 1 in each of the statements).

To enhance completion rate, the researcher also produced colored (different from the SSEQ to avoid monotony) copies of the SAMQ. To enhance return rate, the researcher provided each respondent with a nonmonetary incentive (Appendix 23). Data collected by this instrument were used to address the third and fourth objectives of this study.

3.7.3 Students' Entry Behavior Achievement Test (SEBAT)

Just as its name suggests, the purpose of the SEBAT was to determine students' entry behavior in Chemistry, so as to ascertain their homogeneity. The SEBAT (Appendix 7) was a one-hour achievement test of 60 marks, which was administered as pre-test to all the sampled students. It had 18 items that were developed by the researcher by constructing questions that cut across the Chemistry curricula of forms 1, 2 and 3, using a blue print (Table 3.4) to enhance its face and content validity. All items therein were set in line with the specific instructional objectives outlined in the KICD syllabuses. The items cut across all six levels of the Bloom's cognitive domain of objectives and spread out in ratio 6:3:1 for Low level (knowledge and comprehension), Middle level (application and analysis) and High level (synthesis and evaluation) respectively, like the KNEC does.

Table 3.4: Test Specification Grid for the SEBAT

SOURCE	COGNITIVE LEVEL			TOTAL
	LOW	MIDDLE	HIGH	
FORM 1	7	2	1	10
FORM 2	12	6	2	20
FORM 3	17	10	3	30
FORMS 1 - 3	36	18	6	60

A students' score in the SEBAT was determined by converting his or her total marks to percentage. The maximum possible achievement score in the SEBAT was therefore 100% (for a student who obtained maximum scores in each of the items therein) while the minimum possible score was 0% (for the student who obtained

zero marks in all the 18 items therein). Data collected by the SEBAT were used to address the first objective of this study.

3.7.4 Students' Electrochemistry Achievement Test (SEAT)

The SEAT (Appendix 9) was administered as post-test to all the sampled students, to measure their understanding of concepts taught in the topic of Electrochemistry. It was a one hour achievement test, worth 30 marks, whose items were all short answer, set by the researcher using a blue print (Table 3.5) to enhance its face and content validity. Each question was allocated between 1 and 4 marks.

Table 3.5: Blue Print for the SEAT

CONTENT	COGNITIVE LEVEL			Total
	Low	Middle	High	
Redox reactions	4	-	-	4
Displacement reactions	-	1	-	1
The electrochemical cell	2	-	1	3
Standard electrode potentials	1	1	1	3
Calculating the E.M.F of a cell using E^{θ} values	2	1	1	4
Electrolysis	1	3	-	4
Preferential discharge of ions	4	-	-	4
Quantitative treatment of electrolysis	-	3	-	3
Fuel cells	4	-	-	4
TOTAL	18	9	3	30

As Table 3.5 reveals, all question items in the SEAT covered the six levels of the Bloom's cognitive domain of objectives, and were weighted using the KNEC's criteria of low level (knowledge and comprehension) as the majority, followed by middle level (application and analysis), then high level (synthesis and evaluation) as the minority, in ratio 6:3:1 respectively. All items intended to measure achievement

in electrochemistry were arranged in section I of the SEAT, which had 10 theory questions, worth 30 marks. Section II of the same instrument was a practical question worth 25 marks, which tested the use of several experimental skills by students in the electrochemistry practical test. The skills were assessed using another instrument, which is discussed in the next section, as it collected data for a different objective.

A students' score in the SEAT was determined also by converting their total marks to percentage. The maximum possible achievement score in the SEAT was therefore 100% (for a student who obtained maximum scores in each of the items therein) while the minimum possible score was 0% (for the student who obtained zero marks in all the 10 items therein). Section B was meant for a different objective, which will be discussed in the next sub-section. Data collected by the SEAT was used to address all the five research objectives.

3.7.5 Students' Experimental Skills' Checklist (SESC)

The SESC (Appendix 13) was an observation checklist, which was designed by the researcher to measure students' experimental skills in Chemistry after intervention. The SESC was filled by the research assistants as the selected students were attempting question number 11 in section 2 of the SEAT. This was a practical question, worth 25 marks, which required students to use seven experimental skills namely; arranging, connecting, measuring, recording, assembling, reading and polishing.

The research assistants were trained by the researcher on how to assess, evaluate and rate on a scale of 1 to 5, how effectively the students were using their experimental skills to perform the experiment, using the provided laboratory apparatus and chemicals. The experimental skills in question were scored basing on how well the students were using them i.e. Excellent=5, Good=4, Average=3, Poor=2 and Very Poor=1. Each student's score in the SESC was obtained by converting their cumulative score in all the seven skills to percentage. The maximum possible score in the SESC was therefore 100% while the minimum possible score was 20%. Data collected by the SESC was used to address objectives (iii) and (iv) of this study.

3.7.6 Focus Group Interviews (FGI) Guide

A series of focus group interviews were conducted one day after the quantitative aspect of this study. A total of 10 focus groups, comprising of 73 interviewees were used. This number was arrived at by selecting a sub-sample of between 6 and 10 students from each of the 10 research groups, all on a volunteer basis as earlier mentioned. A set of guiding questions (Appendix 14) were developed prior to the start of the study to guide the moderators of the FGI i.e. the interviewers.

These guiding questions were related to what participants experienced from the research and while sitting for the SEAT, their perspectives on learning of Chemistry and electrochemistry as a topic, challenges they may have faced during learning of electrochemistry and how they overcame them. The interview protocols had embedded probes to guide the interviewer. Students' responses to items in the FGI were analyzed in themes as they emerged. The qualitative data collected by this

instrument were used to give more elaborate explanations to the quantitative findings made with respect to the other previously mentioned instruments.

3.8 Pilot Study

A pilot study was carried out two weeks prior to the actual study, in two secondary schools within Kakamega County, which offer computer studies. The pilot school was expunged from the study sampling frame before the actual study, so as to avoid redundancy and *hallo* effect in the actual study (Long-Crowell, 2015). Data collected from the pilot study were used to assess validity and reliability of the research instruments.

3.8.1 Validity of the Research Instruments

An instrument is said to be valid if it measures what it purports to measure (Pearl, 2015). To ascertain this, the Rasch Model was used. For the SESC, SSEQ, FGI and SAMQ, the researcher supplied three experts from the department of Science and Mathematics Education (SME) of Masinde Muliro University of Science and Technology (MMUST), with a rating scale and scoring guide (Appendix 16) for this purpose. The experts were requested in writing (Appendix 16) to scrutinize, critique and assess the content validity of these four instruments.

As for the SEBAT and SEAT, the researcher sought the input of three experienced KNEC examiners of KCSE papers 233/1, 233/2 and 233/3, also by giving them a rating scale (Appendix 16). Comments from the experts were used by the researcher

to modify the instruments, so as to make them more ideal and accurate for data collection in the actual study.

The SSEQ, SAMQ, SEBAT, SEAT, SESC and the FGI were awarded average percentage validity scores of 74, 86, 85, 81, 82 and 77 respectively. Therefore, validity scores awarded to each of these instruments by the various experts were all above the minimum recommended score of 60% for educational researches (Kahn and Best, 1998). These scores implied that the instruments had a strong ability to measure what they purported to measure.

3.8.2 Reliability of the Research Instruments

A research instrument is said to be reliable if it can produce consistent results when administered repeatedly on the same subjects (Aziz, 2010). Quantitative research instruments used in this study were assessed for their reliability before the actual study, using data from the pilot study. This was done via the internal consistency reliability analysis, using Cronbach's alpha coefficients. This method helped in determining each instrument's inter-item correlation on the basis of a correlation matrix for all items in the instruments, and also the corrected item-total correlation, including alpha coefficients that would have been obtained on deleting an item altogether from the instrument. This kind of analysis helped the researcher to detect items that needed modification or removal from the instrument (Peters, 2014).

This method of reliability assessment was used because it required only one test administration, which therefore did not inconvenience the selected schools by

consuming too much of their time. It had been stipulated that an instrument whose calculated alpha coefficient would be equal to or greater than 0.7 would be deemed fit for use in this study, as it would have met the threshold set by George & Mallery, (2003), who came up with the following rules of thumb;

“Greater than 0.9 would be Excellent, greater than 0.8 would be Good, greater than 0.7 would be Acceptable, while greater than 0.6 would be Questionable, greater than 0.5 would be Poor, and less than 0.5 would be Unacceptable” (p. 231).

Going by these standards, items therein whose calculated Cronbach’s alpha coefficients were found to be less than 0.7 were assumed to be defective, and were consequently modified. The reliability analyses indicated that all the five instruments eventually surpassed the minimum acceptable reliability coefficients [*SSEQ: r=0.846, SAMQ: r=0.755, SEBAT: r=0.805, SEAT: r=0.877, SESC: r=0.729*]. These results implied that all the five research instruments that were used to collect quantitative data were of good scholastic quality and if used again under the same research conditions, they would produce a similar outcome.

3.9 Data Collection Procedures

After approval of his research proposal by the School of Graduate Studies (SGS), the researcher obtained a research permit from the National Commission for Science, Technology and Innovation (NACOSTI). A copy of the permit was availed to the research area’s county commissioner, CDE and the respective SEO’s. The sampled schools were pre-visited to inform their respective head teachers and science heads of departments about the impending study.

During this pre-visit, the researcher, with permission from the head teachers, made necessary arrangements with form four Chemistry teachers, through their science heads of departments, about finer details of the study. Five of the ten sampled Chemistry teachers (those assigned to students in the experimental group) were inducted on how to implement SOCM in electrochemistry. Induction lasted for 3 days, two hours on each. Chemistry teachers were officially appointed by the researcher to be his research assistants at this stage.

All the sampled students were thereafter given the SEBAT. The researcher then collected all answer sheets, coded them and supervised their marking, after coordination of their marking scheme (Appendix 8). The ‘conveyor belt’ system of marking was employed, so as to prevent *hallo* effect and subjectivity in the sense that using this system, every examiner marked only his or her part in all the scripts. The SSEQ and SAMQ were then issued in that order to all the sampled students. The SEAT was administered to all the sampled students after a four-week period of teaching and learning electrochemistry.

As the students were attempting item number 11 in the SEAT, which was a practical question, the SESC was filled by their Chemistry teachers under the help and supervision of the researcher. Marking of the SEAT scripts (question 1 to 10) was thereafter done in the same way as was done for the SEBAT, using a marking scheme (Appendix 11). SSEQ and SAMQ were once again administered as posttest to all the sampled students and collected immediately after being completed. One day after administration of the previously mentioned instruments, FGI’s were conducted on some of the students who had participated in the study.

3.9.1 The Intervention: Concept Mapping Softwares

Two of the softwares that were used by students in experimental groups of this study were adopted while one was developed by the researcher, with help from a qualified software engineer. The developed software was christened “MACOMASO”, an acronym for “Masinde’s Concept Mapping Software”. It was original, interactive computer instructional software, named after the researcher, and was designed for use on Windows XP, Windows Vista, Windows 7.0 and Windows 8.1 operating systems. The software was supplied with a user’s manual (Appendix 12), which had step-by-step instructions in simple English language, which explained how to construct, save, edit and print concept maps, using desktop or laptop computers.

Other complimentary softwares namely *Inspiration 9.0* and *Smart Ideas* were used alongside *MACOMASO*, so as to expose the students to a variety of concept map construction skills. The software are different in terms of outlook, ease of use, number and type of drawing tools within the programme, though they all function basing on the same principle. After exposure to the three types of concept mapping softwares, students were eventually able to select and use their favorite software since there was variety. It is worth noting that *Inspiration 9.0* and *Smart Ideas 5.0* were ‘richer’ in concept map construction features as compared to *MACOMASO*, because development of the latter was limited by time and financial constraints.

Inspiration software exists in several versions namely; *Inspiration*, *Kidspiration* and *Webspiration*. According to their product catalogue, they all contain diagram views that make it easy for students to create concept maps. Students are able to add new concepts and links as they fit. They all come with examples, templates and lesson

plans to show how concept mapping and the use of other graphic organizers can easily be integrated into the curriculum to enhance learning, comprehension and writing skills. Free trial versions of this software are downloadable from the internet at <http://www.inspiration.com/freetrial/index.cfm>

According to the manufacturer's description, *Smart Ideas* software on the other hand "brings the power of visual learning into the classroom". Students can better understand and analyze complex ideas by building multilevel concept maps. Multilevel maps take students through concepts one level at a time, for greater clarity and easily converting into a multipage website for everyone to share. Free trial versions of this software is downloadable from the internet at <http://www.smartideas.com>

3.9.2 Software Installation: MACOMASO, Inspiration 9.0 and Smart Ideas 5.0

The three softwares were installed, with permission from head teachers of schools that made up the experimental group, on all students' computers for purposes of teaching and learning electrochemistry during normal Chemistry lessons as scheduled on the school timetable. The researcher trained his research assistants (Chemistry teachers) on how to use them beforehand. A step-by-step user's manual (Appendix 12) was provided to each of the research assistants for reference in case they experienced any difficulties using the software. Poster size copies of the manuals were also pinned on the walls of the computer laboratories for students' access. The research assistants demonstrated to students how to construct concept maps using the software. Figure 3.4 shows a sample electrochemistry concept map, drawn using one of the softwares, by one of the students who took part in this study.

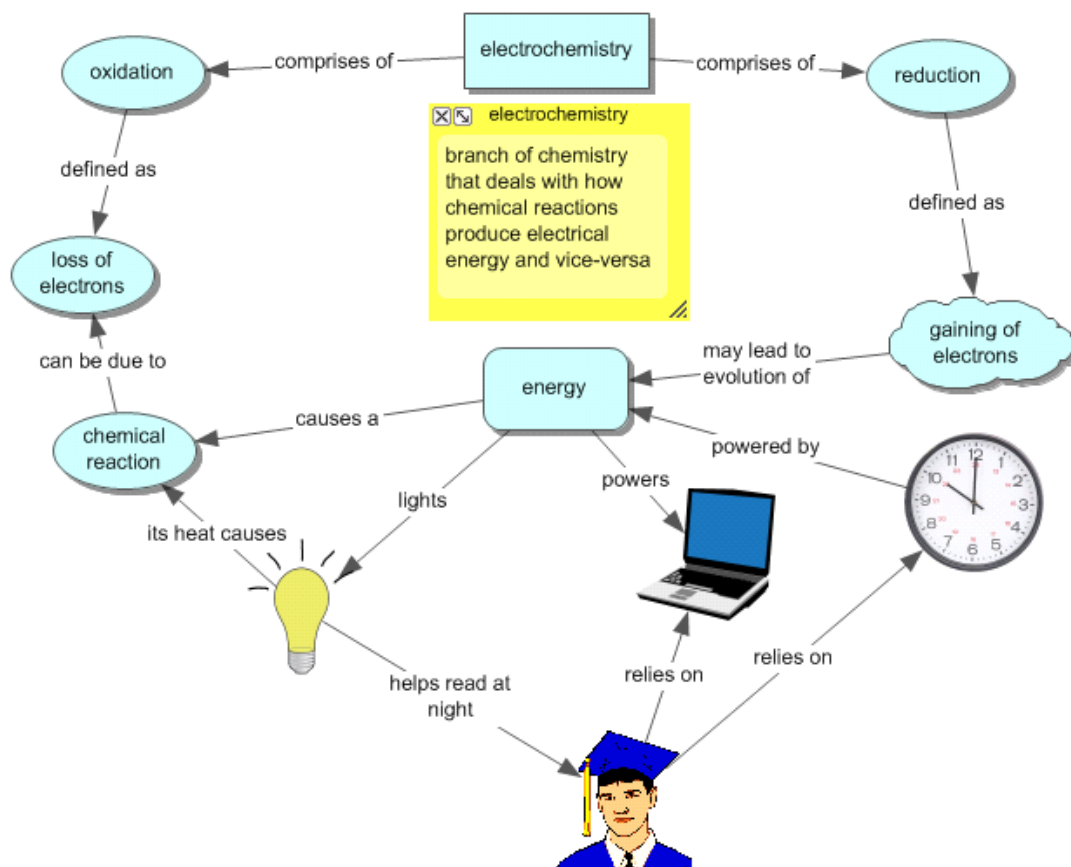

Figure 3.4: Sample Software-Drawn Electrochemistry Concept Map

(Source: Respondents of this study)

The researcher validated all these softwares using software engineers, other than those who helped to develop it, together with government officers from the KICD. All the softwares were used only after it was ascertained that they would cause no harm or undesirable effects to its users.

3.10 Data Analysis Procedures

This being a mixed methods study, both qualitative and quantitative data were collected. To facilitate analysis, the raw data were coded in SPSS and analyzed descriptively to generate frequencies, percentages, means and standard deviations.

These descriptive measures were used to supplement inferential tests by giving explanations that delineated the proportional amount of experimental skills, self-efficacy, motivation, attitude and achievement in electrochemistry, between the experimental and control groups and also to account for any differences between the ten groups under comparison.

Quantitative data were analyzed inferentially, using parametric tests namely; one-way Analysis of Variance (ANOVA), Bivariate Pearson's Correlation (BPC), Analysis of Covariance (ANCOVA), Standard Multiple Linear Regression (SMLR) and univariate ANOVA, 2×1 Factorial to be specific, to test the study's first, second, third, fourth and fifth null hypotheses respectively, all at the 0.05 significance level.

One-way ANOVA was used to test H_{01} because data collected by this study's achievement tests were expected to meet assumptions of this test, which are; (i) there should be more than two groups, categorized basing only on one factor - this study had ten groups, categorized basing only on the type of treatment they received, (ii) Data should be normally distributed. This was expected to be the case since intact classes were assigned randomly into experimental and control groups. Nevertheless, the Shapiro-Wilk test was used to assess this assumption beforehand. (iii) Data should be continuous.

The SEAT was an achievement test, whose possible scores ranged on a continuous ratio scale of 0 to 100. Absolute zero in the SEAT therefore meant absence of the variable, (iv) the groups should not be related - this assumption was already taken

care of by the research design, as it entailed the use of intact classes. This meant there was no chance of a participant belonging to more than one treatment group i.e. being in experimental as well as control groups (iv) the groups should have equal variances. This assumption was assessed using Levene's test of homogeneity of variances.

BPC was used for H_{O2} to determine the direction and strength of association between students' self-efficacy and achievement, as measured by the SSEQ and SEAT respectively. This was because data that were collected with respect to this hypothesis were expected to meet the earlier stated assumptions of parametric tests. On top of these, it was assumed that the true association between self-efficacy and achievement was linear, as it was found to be the case while reviewing related studies (Aurah, 2013). This assumption was nevertheless assessed using scatter diagrams.

ANCOVA was used to test H_{O3} , whose data were collected by the SAMQ, SESC and SEAT. The test was used because data that were collected by these instruments met all the previously mentioned assumptions of parametric tests. On top of these, the researcher believed there were other factors, other than the independent variables, herein referred to as 'covariates', that may also influence achievement, which warranted control, while testing for interaction between some of the independent variables, which made ANCOVA the most appropriate test. The covariate here was students' pretest achievement scores.

SMLR was used to test H_{04} because apart from the fact that the data collected with respect to this hypothesis met assumptions of parametric tests, the researcher wanted to establish whether the dependent variable (achievement) could be determined using attitude, self-efficacy, motivation and experimental skills as predictor variables. SMLR was the most robust for doing this.

Univariate ANOVA, 2×1 factorial to be exact, was on the other hand used to test H_{05} , because there was one dependent variable (achievement) being investigated, whose data were to be analyzed basing on two factors that the selected students were grouped for the sake of data analysis. These were students' gender and school type.

Descriptive statistics namely; frequencies, percentages, mean and standard deviations were generated from the raw data, with the aim of giving explanations to some of the observations and trends that emerged, which could not be sufficiently explained by inferential statistics.

Frequencies and percentages were used to describe the relevant demographic information about the study's respondents. On the other hand, mean scores were used to describe the differences between the treatment groups, with respect to the study's dependent variables. Standard deviations on the other hand were used to describe how the sampled students' scores were spread out with respect to the mean. Descriptive analysis therefore did not stand alone, but was rather used to supplement the inferential statistics by accounting for the observed differences and similarities in the sampled students with respect to the variables under investigation.

Qualitative data on the other hand, which were obtained from the Focus Group Interviews, were coded and analyzed in line with the study's objectives, according to themes as they emerged. Finally, the researcher determined effect size of the differences observed among the treatment groups during data analysis and used it as a basis of making recommendations, as will be explained in chapter five of this work. This was because as Stegenga, (2015) puts it, "... *Not all significant findings are important*". Effect size for this study therefore informs any parties interested in findings of this study, who might want to make critical decisions on matters policy.

3.11 Ethical Considerations

In an attempt to adhere to principles of research integrity, several measures were put in place by the researcher to ensure that the rights of all participants of this study were not violated in any way. The researcher has acknowledged all sources of information that was used to develop this work, so as to avoid plagiarism. The researcher also obtained a research permit (Appendix 2) and authorization letter (Appendix 3) from NACOSTI, before going to the field to collect data, so as to ensure that his study was legal under Kenyan Law.

The researcher also sought consent from all respondents before using them in the study. This was done by asking them to sign informed consent forms (Appendix 15), one week to the actual study. This ensured that no respondent felt coerced or forced in any way to give information for this study against their wishes. To build confidence in the respondents, the researcher assured them of their anonymity and confidentiality of all information they divulged. Only pseudo names were used instead of actual names of respondents and their schools for this reason. This

ensured maximum cooperation from respondents, who as a result, “opened up” fully without fear of arousing controversy or being reprimanded.

The researcher selected respondents of this study in their intact classes, so as not to disrupt or destabilize smooth running of other school systems. Furthermore, before the respondents were exposed to the study’s instructional softwares, the researcher first validated them, using government officers from KICD and a software engineer, who after ascertaining they had no prohibited content, gave it a clean bill of health. Additionally, letters of appreciation (Appendix 20) were written and dispatched to all students, teachers and principals of schools that were used in this study, to thank them for the various roles they played in this study. Finally, the researcher has ensured that the findings of this study are accurately reported, without making any undue changes, exaggerations, alterations or falsifications.

CHAPTER FOUR:

PRESENTATION, INTERPRETATION AND DISCUSSION OF FINDINGS

4.1 Main Highlights of Chapter Four

This chapter presents the results of statistical analyses that were done on the research data, together with their interpretation, followed by a discussion of these results with respect to all research objectives. Qualitative findings are also presented, followed by a brief discussion about effect size. Data were used to meet the five objectives of the study as outlined in chapter one, which were; (i) to determine whether there is a difference in achievement between students taught electrochemistry using SOCM and those taught via the CIS, (ii) to determine the association between students' self-efficacy and achievement in electrochemistry when taught using SOCM and the CIS, (iii) to determine the extent to which students' experimental skills and attitude interact to influence their achievement in electrochemistry when taught using SOCM and the CIS, (iv) to establish the extent to which learning indicators could predict students' achievement in electrochemistry when taught using SOCM and the CIS (v) to establish the differential effects of SOCM and the CIS on students' achievement in electrochemistry by gender and school type.

4.2 Data Screening

Several steps were taken to screen for accuracy and quality of the research data. The Missing Value Analysis program from SPSS version 21 was used to assess missing values. Data were also screened by running descriptive statistics and examining the range of values on all variables. This process revealed some erroneous data entry.

Given this, all values in the data sets were compared to the values on the hardcopy questionnaires. That is, any case in the data set that had a value beyond the allowable range for a given variable was reviewed in its entirety to pinpoint the errors. After the data screening, no cases out of the 400 remained in the programme for further analyses. Finally, data were examined for consistency checks to ensure logical relationships among variables, for example, no male students in a “girls’ only” school and vice-versa. Variables with questionable values were chosen for closer examination by reviewing the instruments’ filled hardcopies. The values on the questionnaires were compared to the values entered in the data file. This revealed that some of the questionable values were also due to erroneous data entry. All inconsistent values were eventually located and rectified accordingly hence prior to analysis, 100% of the cases were available and logically consistent.

4.3 Preliminary Data Analyses

Prior to the actual data analyses, several preliminary analyses were performed to establish all the requisite demographic information about the respondents of this study. Results of this analysis were as displayed in Table 4.1.

Table 4.1: Proportions of Respondents by their Gender and School Type

Group	Gender			School Type			
	M	F	Total	Mixed	Boys	Girls	Total
Experimental	116	84	200	122	43	35	200
Control	100	100	200	117	42	41	200
Total	216	184	400	239	85	76	400

As Table 4.1 reveals, the experimental and control groups of this study were equal in size, as they each comprised of 200 respondents, making a total sample size of 400 form four students. Of these, 216 were male and 184 female, which meant that male students were slightly more (54%) than females, who were 46 % of the entire sample. Table 4.1 further reveals that respondents from mixed (co-educational) schools, who were 239, formed a majority of 59.7%. They were followed by boys' schools, which contributed 85 respondents, which was 21.3% of the sample, while girls' schools produced the fewest respondents numbering 76, which was 19% of the entire sample.

Return rates of all the research instruments were calculated to determine the whether there was any wastage of research instruments or inefficiency on the part of research assistants. Results were as presented in Appendix 21, which indicates that no instruments were uncollected by the end of the data collection exercise. This is especially so because taking the SSEQ and SAMQ for instance, they both had maximum possible return rates of 100%.

Return rates of the SSEQ and SAMQ were also established to be 100% since all the copies administered were returned within the stipulated time frames. Return rates for the SEBAT, SESC and SEAT were also 100%. Going by these ideal return rates, no data wastage of hard copies was therefore recorded in this study. This important milestone was achieved as a result of several measures that were put in place by the researcher. These included (i) supervision of the whole exercise, where both the researcher and his research assistants were physically present to invigilate and take care of anything that demanded immediate attention, (ii) sensitization of respondents

about the importance of their responses and how future policy action might depend on the information they were about to give and (iii) production of colored copies of these instruments , (iv) use of a sufficient number of effective research assistants and (v) careful packaging and safe custody of all the hard copies of the research materials. It took 40 minutes on average to administer both questionnaires.

Completion rates for all research instruments that were administered and returned were also calculated prior to actual data analysis to determine whether any significant amounts of data were lost in the course of the study. This was done by dividing the number of items fully responded to in each instrument by the corresponding total number of items therein and multiplying the quotient by 100. Appendix 22 presents the completion rates that were obtained for each of the research instruments used in this study, which reveals that the completion rate was highest in the SESC at 99%, followed by the SSEQ at 98%.

The SAMQ, SEAT and SEBAT had completion rates of 97%, 92% and 85% respectively. These relatively high completion rates imply that very small hence insignificant amounts of data were lost in the course of data collection. This is a very important milestone in research (Fan and Yan, 2010), which was achieved because of a raft of measures that the researcher put in place to guard against any loss of significant amounts of data. These included; (i) assurance of anonymity of the respondents, through the use of pseudo names instead of actual names, (ii) assurance of confidentiality of information given prior to administration, (iii) production of colored copies of these instruments, (iv) allocation of sufficient amounts of time needed for most learners to respond to all items in each instrument. This decision

was informed by the researcher's observations from the pilot study, (v) frequently reminding the respondents about the amount of time left while the achievement tests were being sat for, (vi) clear articulation of the importance of this study beforehand, (vii) provision of simple and clear instructions on how each instrument was to be filled and (viii) avoiding jargon and instead, using language commensurate to the respondents' level of education.

4.4 Statistical Assumptions

All hypotheses of this study were tested inferentially using parametric tests, which rely on many assumptions. These assumptions if violated, may lead to commission of type I or type II errors in the course of hypothesis testing (Cox, 2006). For this reason, all statistical assumptions of each parametric test used during inferential data analysis were assessed beforehand, so as to leave no room for committing any of the two previously mentioned statistical errors, both of which cannot be ignored, because doing so is tantamount to disseminating misleading findings.

4.4.1 Assumptions for One-Way Analysis Of Variance

This test was used for H_{01} . It demands that data should be normally distributed. This assumption was assessed by performing the Shapiro-Wilk test on the students' scores in the SEAT, whose data were used to meet the first objective and H_{01} . Results of this test as presented in Appendix 18, yielded a non-significant p-value [$w(400)=.994$, $p=.131$ at $\alpha=.05$], which implied that the data were normally distributed, hence the assumption of normality was met.

One-way ANOVA also demands that the groups sampled should have equal variances. This assumption was assessed using Levene's test of homogeneity of variances, whose results as presented in Appendix 19, yielded a non-significant p-value [$F(1, 398) = 6.191, p = .211$ at $\alpha = .05$]. This implied that the difference in variances between the groups under investigation was not significant, hence this assumption was met.

Data to be analyzed using one-Way ANOVA must also be quantitative or at least on ordinal scale. Students' scores in the SEAT were scored on a ratio scale of zero to 100, which is indeed continuous data. This assumption was therefore met because absolute zero meant total absence of the variable academic achievement.

4.4.2 Assumptions for Bivariate Pearson's Correlation

Some of the assumptions of this test can easily be overlooked (Haghighat, Abdel-Mottaleb & Alhalabi, 2016). They are as follows; level of measurement, related pairs, absence of outliers, normality of variables, linearity and homoscedasticity (Nicolic, Muresan, Feng' and Singer, 2012). Level of measurement refers to each variable. For a Pearson's correlation, each variable should be continuous and if one or both variables are ordinal in measurement, then a Spearman's correlation should be conducted instead (Haghighat *et al*, 2016). In this test for the second null hypothesis, H_{02} , students' self-efficacy scores and their achievement scores were the variables under scrutiny, both of which were on continuous interval and ratio scales respectively.

Related pairs refer to the pairs of variables. Each participant or observation should have a pair of values (Nikolic, 2012). So if the correlation was between self-efficacy and achievement, like it was the case in the second null hypothesis, then each observation used should have both a posttest self-efficacy score and a posttest achievement score. This was the case in this study because the case-wise diagnostics performed while screening the data as earlier discussed revealed no missing values.

Absence of outliers refers to not having any values in either variable that are distant from the rest in a data set (Ijsmi, 2017). Having an outlier can skew the results of the correlation by pulling the line of best fit formed from the correlation too far in one direction or another (Haghighat *et al*, 2016). Typically, an outlier is defined as a value that is 3.29 standard deviations from the mean, or a standardized value of less than ± 3.29 units. There were no outliers in the data collected by the SSEQ and SEAT as all the values fell within the prescribed parameter margins.

Homoscedasticity refers to the shape of the graph formed by the scatter plot (Gwilym, 2017). For linearity, a “straight line” relationship between the variables should be formed. If a line were to be drawn between all the dots, going from left to right, the line should be straight and not curve. In this regard, homoscedasticity refers to the distance between the points in that straight line. The shape of the scatter plot should be tube-like. If the shape is cone-like, then homoscedasticity would not be met (Marno, 2012). To this end, the scatter plots drawn, with students’ posttest achievement on the y-axis and posttest self-efficacy scores on the x-axis revealed a tube-like shape, with the dots on a straight line or thereabouts, hence the assumption of homoscedasticity was met.

4.4.3 Assumptions for Analysis of Covariance

ANCOVA was used to test H_{03} . It demands that data to be analyzed must be continuous in nature (Miller & Chapman, 2011). The SESC and the SAMQ, which were used to collect data for this hypothesis, were scored on scales ranging between 20 and 100. Since there was no absolute zero on these scales, the data were assumed to be on interval scale, which is still quantitative and hence this assumption was met.

This test further demands that data should be normally distributed (Howell, 2009). This assumption was assessed by performing the Shapiro-Wilk test on the students' scores in the SESC and SAMQ (attitude part of the questionnaire), which were used to collect data for the third objective of this study. Results of this normality test as presented in Appendix 18 revealed a significant p-value for students' posttest attitude [$w(400) = .964$, $p < .001$ at $\alpha = .05$], and a non-significant one for posttest experimental skills [$w(400) = .993$, $p = .460$ at $\alpha = .05$].

These values implied that while the experimental skills scores were normally distributed, those of posttest attitude were not, hence the assumption of normality was partially violated because of the skewed attitude scores. However, since the sample size used was large enough, failure of this variable to meet the assumption of normality was not expected to have any negative effect on the analysis results. This is according to the central limit theorem, which explains that provided the sample size used is large enough, the sampling distribution of the mean will always approach normality or nearly normal (Barany and Van, 2007). In retrospect, 400 respondents were used instead of the required 350, for technical reasons already explained in chapter three.

Additionally, ANCOVA requires that for each independent variable, the relationship between the dependent variable (y) and the covariate (x) is linear (Green & Salkind, 2011). This assumption was assessed by drawing scatter diagrams, with posttest achievement on the y-axis and posttest experimental skills on the x-axis. On the same graph, a separate scatter diagram was drawn, with posttest achievement on the y-axis and posttest attitude on the x-axis. Both graphs suggested a linear relationship between the respective variables since the resulting lines, though not parallel, their slopes were quite similar, which indicated that homogeneity of the slopes was met.

4.4.4 Assumptions for Standard Multiple Linear Regression

Standard Multiple Linear Regression (SMLR) was used to test H_{04} . Data for this hypothesis were checked to assess if the statistical assumptions were met for linearity, outliers, multivariate normality, homoscedasticity, first order autocorrelations, independence, and multicollinearity. The assumption of linearity was assessed by visual inspection of a matrix scatter plot. The plot indicated positive linear relationships between the predictor variables and the outcome variable, hence no violation was committed (Aurah, 2013; Tabachnick & Fidell, 2007).

The remaining assumptions were assessed after running multiple regression analyses with posttest achievement as dependent variable and drawing residual plots. Outliers were identified by examining the standardized Z-scores. There were 12 cases that had Z-scores in excess of ± 1.96 in the regression analysis, indicating that these cases were outliers. Observations that stray outside of the 95% confidence envelope are statistically significant outliers (Aurah, 2013; Green & Salkind, 2011; Tabachnick & Fidell, 2007). However, given a sample size of 400, and using the

95% rule of thumb, there was room for having 20 outliers in the data without causing any statistical blunders.

Normality of residuals was tested using the Shapiro-Wilk test. The analysis as shown in Appendix 18 yielded a non-significant p-value for posttest achievement as earlier explained, which implied that students' scores in the SEAT were normally distributed. A residual plot was inspected for homoscedasticity, independence and linearity of residuals. The residual points were randomly and evenly dispersed throughout the plot. This pattern implied that the assumption of homoscedasticity was met (Howell, 2009).

There being no known direct test for multivariate normality, each variable was tested separately and all were assumed to be multivariately normal because they were individually normal, though this may not necessarily be the case. Diagnostic hypothesis tests for normality were carried out as a result, using the rule of thumb that says a variable is reasonably close to normal if its skewness and kurtosis have values of between ± 1 (Sharma & Bhandari, 2013). The skewness and kurtosis for all variables tested in this study were within this range, hence the assumption of multivariate normality was met.

To check for first order autocorrelations, Durbin-Watson statistic was examined. This statistic informs us whether or not the assumption of independent errors is tenable (Marno, 2012). Values less than 1 and greater than 3 are worrisome, but the closer the value is to 2, the better. In the regression analysis, the Durbin-Watson

statistic was 1.8 units. The assumption that the residuals from a multiple regression are independent was therefore met.

Multicollinearity was tested by using Variance Inflation Factor (VIF) and Tolerance values. Specifically, VIF values greater than 10 and tolerance values below 0.10 indicate multicollinearity in the data (Kutner, Nachtsheim & Neter, 2004). Based on these criteria, no collinearity among the variables of interest was indicated. The VIF values were well below 10 (ranging from 0.073 to 1.891) and the tolerance statistics were all well above 0.20 (ranging from 0.599 to 0.916) for the regression model. Therefore multicollinearity was ruled out as a source of concern for this study.

4.4.5 Assumptions for 2 × 1 Factorial Analysis of Variance

2×1 factorial ANOVA was used to test $H_{0.5}$. Normality of data used for this fifth objective of the study was assessed using the Shapiro-Wilk test, whose results as presented in Appendix 18 indicated the data were normally distributed. 2×1 factorial ANOVA requires that the sampled groups should have approximately equal variances. This assumption was tested using Levene's test for homogeneity of variances, whose results as shown in Appendix 19 yielded a non-significant F-ratio [$F(1, 398) = 6.191, p = .211$ at $\alpha = .05$], which implied that this assumption underlying the application of the two-way ANOVA was met (Gelman, 2008).

4.5 Descriptive Statistics

Several descriptive measures were computed on data that were collected by the research instruments, with the intention of establishing trends and patterns that would give explanations to some of the observations made in the analysis of quantitative data.

4.5.1 Descriptive Analysis of Students' Pretest Dependent Variables

Students' pretest achievement, Self-efficacy (S.E), attitude, motivation and Experimental Skills (E.S) as measured by the SEBAT, SSEQ, SAMQ and the SESC were analyzed descriptively to generate Means and Standard Deviations (S.D) and the outcome was as presented in Table 4.2.

Table 4.2: Means and Std. Deviations of the Pretest Dependent Variables

Group	Statistic	S.E	Attitude	Motivation	E.S	Achievement
Experimental (N=200)	Mean	65.31	59.87	63.86	69.50	39.51
	S.D	7.034	7.426	8.370	9.897	9.116
Control (N=200)	Mean	65.13	60.25	63.42	69.59	40.23
	S.D	7.292	6.642	9.046	11.27	9.576
Both (N=400)	Mean	65.22	60.06	63.64	69.54	39.87
	S.D	7.156	7.039	8.706	10.59	9.344

It can be observed from Table 4.2 that with respect to self-efficacy, the experimental and control groups had relatively similar mean scores, [*mean (experimental)=65.31, S.D=7.034, Mean (Control)=65.13, S.D=7.292*] and so was the case with their pretest attitude scores [*mean (experimental)=59.87, S.D=7.426,*

Mean (Control)=60.25, S.D=6.642]. Furthermore, it can be seen from Table 4.2 that students' motivation scores in the pretest were fairly similar [*mean (experimental)=63.86, S.D=8.370, Mean (Control)=63.42, S.D=9.046*]. This was also the case with pretest experimental skills [*mean (experimental)=69.50, S.D=9.897, Mean (Control)=69.59, S.D=11.27*].

Additionally, Table 4.2 reveals a similar trend in the pretest achievement scores, albeit lower in magnitude as compared to the previously discussed variables [*mean (experimental)=39.51, S.D=9.116, Mean (Control)=40.23, S.D=9.576*]. Moreover, it can be seen from Table 4.2 that students' overall pretest scores in all the dependent variables were relatively similar to those of the experimental and control groups [*Mean (Self-Efficacy)=65.22, S.D=7.156, Mean (Attitude)=60.06, S.D=7.039, Mean (Motivation)=63.64, S.D=8.706, Mean (Experimental Skills)=69.54, S.D=10.59, Mean (Achievement) =39.87, S.D= 9.344*].

4.5.2 Descriptive Analysis of Students' Posttest Dependent Variables

Students' scores in all the posttest dependent variables namely self-efficacy, attitude, motivation, experimental skills and achievement as measured by the SSEQ, SAMQ, SESC and the SEAT were analyzed descriptively to generate means and standard deviations and the results were as presented in Table 4.3, from which it can be observed that the experimental group obtained a relatively higher mean score in post test self-efficacy as compared to the control group [*Mean (experimental)=78.73, S.D=6.919, Mean (control)=64.85, S.D=7.189*].

Table 4.3: Means and Std. Deviations of the Posttest Dependent Variables

Group	Statistic	S.E	Attitude	Motivation	E.S	Achievement
Experimental (N=200)	Mean	78.73	81.78	76.32	70.90	58.87
	S.D	6.919	6.994	8.932	9.348	11.08
Control (N=200)	Mean	64.85	60.09	65.60	69.16	50.31
	S.D	7.189	6.942	8.544	9.920	11.15
Both (N=400)	Mean	71.79	70.93	70.96	70.03	54.59
	S.D	9.894	12.90	10.25	9.666	11.90

It can further be observed from Table 4.3 that the experimental group also obtained a relatively higher attitude mean score as compared to the control group [*Mean (experimental)=81.78, S.D=6.994, Mean (control)=60.09, S.D=6.942*]. Moreover Table 4.3 points out that students' posttest motivation scores were higher in the experimental group as compared to those of the control group [*Mean (experimental)=76.32, S.D=8.932, Mean (control)=65.60, S.D=8.544*].

As regards students' experimental skills in the posttest, Table 4.3 shows that the mean scores of both the control and control groups were fairly equal [*Mean (experimental)=70.90, S.D=9.348, Mean (control)=69.16, S.D=9.920*]. Superior mean scores were however recorded by the experimental group with respect to posttest achievement as Table 10 clearly indicates [*Mean (experimental)=58.87, S.D=11.08, Mean (control)=50.31, S.D=11.15*]. It is apparent from the overall mean scores as displayed in Table 4.3 that students obtained lower scores in their posttest achievement as compared to the rest of the variables. This can be explained by the fact that the achievement test scale was broader, ranging from 0 to 100, while

those of attitude, motivation and self-efficacy were narrower, as they each ranged from 20 to 100.

It can be deduced from a critical analysis of both Tables 4.2 and 4.3 that the experimental group had a higher mean gain in all the five dependent variables [*Self-efficacy: Mean gain (experimental)=13.42, Mean gain (control)=0.28, Attitude: Mean gain (experimental)=21.91, Mean gain (control)=0.16, Motivation: Mean gain (experimental)=12.46, Mean gain (control)=2.18, Experimental Skills: Mean gain (experimental)=1.4, Mean gain (control)=0.43, Achievement: Mean gain (experimental)=19.36, Mean gain (control)=10.08*]. Notably, both groups had a positive deviation in achievement mean score, which was attributed to the fact that the posttest was narrower in scope, covering only one topic, unlike the pretest which covered 15 topics from forms one up to three. Students' scores in the SEAT were also analyzed according to their gender and type of school they were enrolled in. The mean and standard deviation of each gender and school type were computed and the results were as presented in Table 4.4.

Table 4.4: Analysis of Posttest Achievement by Gender and School Type

GENDER	SCHOOL TYPE	MEAN	S.D	N
Male (N=216)	Mixed	54.74	11.70	131
	Boys'	54.16	12.38	85
	Total	54.51	11.95	216
Female (N=184)	Mixed	55.00	12.33	108
	Girls'	54.22	11.27	76
	Total	54.68	11.88	184
Both (N=400)	Mixed	54.86	11.96	239
	Girls'	54.22	11.27	76
	Boys'	54.16	12.38	85
	Total	54.59	11.90	400

As we can see from Table 4.4, the achievement mean scores of male students were relatively similar across all school types [*Mean (Mixed)*=54.74, *S.D*=11.70, *Mean (Boys')*=54.16, *S.D*=12.38], and so was the case among female students [*Mean (Mixed)*=55.00, *S.D*=12.33, *Mean (Girls')*=54.22, *S.D*=11.27]. It can further be deduced from Table 4.4 that mixed schools produced a slightly higher achievement mean score as compared to the single gender schools. *Mean (Mixed)*=54.86, *S.D*=11.96, *Mean (Girls')*=54.22, *S.D*=11.27 and *Mean (Boys')*=54.16, *S.D*=12.38].

4.6 Inferential Statistics

To find out if the differences observed in the posttest scores as given in the descriptive analyses were significant or not, inferential statistics were employed. Several parametric tests were carried out at the 0.05 alpha level of statistical significance to test the five null hypotheses that were derived from each of the five research objectives.

4.6.1 Results of Objective One

The first objective of this study as outlined in Chapter one of this work was to determine whether there is a difference in achievement between students taught electrochemistry using SOCM and those taught via the CIS. Data with respect to this objective were collected using the Students' Entry Behavior Achievement Test (SEBAT) as pretest and the Students' Electrochemistry Achievement Test (SEAT) as posttest. The first null hypothesis of this study was formulated from this objective as follows:

H_{01} : *There is no significant difference in achievement between students taught electrochemistry using SOCM and those taught via the CIS*

To test this hypothesis, one-way ANOVA was performed on all the pre- and posttest achievement scores, and the results were as presented in Table 4.5.

Table 4.5: One-Way ANOVA on Students' Achievement Scores

SOURCE	TEST	D.F	F	P
Between Groups	Pre test	9	0.419	0.925
	Post test	9	6.852	0.000
Within Groups	Pre test	390	-	-
	Post test	390	-	-
Total	Pre test	399	-	-
	Post test	399	-	-

Table 4.5 reveals that there was a significant difference in the posttest achievement scores between the ten groups under comparison [$F(9, 390) = 6.852, p < .001$ at $\alpha = .05$]. This is because the p-value obtained is less than 0.05, the stipulated alpha. To find out the specific groups that accounted for this significant F-value, Tukey's post-hoc Least Significant Difference (LSD) tests were carried out.

These follow-up tests revealed that all experimental groups produced non-significant p-values when compared against each other and so was the case when control groups were compared against each other. However, significant p-values were obtained when all the experimental groups were compared against all the control groups. This implied that the experimental groups had significantly higher mean scores in the posttest achievement test than the control groups. Table 4.5 further reveals that in the pretest, there was no significant difference in mean score between

the 10 groups under investigation [$F(9, 390) = .419, p = .925$ at $\alpha = .05$]. This was because the p-value was greater than 0.05, the stipulated alpha level.

For these reasons, first null hypothesis was rejected because empirical evidence that arose from data collected with respect to the first objective suggested the contrary assertion. It can now alternately be asserted that there is a significant difference in achievement between students who are taught electrochemistry using SOCM and those who are taught using the conventional approaches in favor of the former.

4.6.2 Discussion of Findings From the First Objective/H₀₁

It was established that the use of SOCM in teaching and learning of electrochemistry had a significant positive impact on students' achievement in the topic than when the Conventional Instructional Strategies were used. This was because students in all the experimental groups of this study were taught electrochemistry using SOCM and obtained significantly higher scores than their counterparts in all the control groups, who were taught the same topic using the CIS. A similar comparison in the pretest achievement test however showed that all the groups had statically the same achievement entry behavior. This difference in post test achievement was therefore attributed by the researcher to the treatment that the experimental groups received.

These findings are in agreement with those of Cheema and Mirza, (2013), whose study revealed that the use of concept mapping in general science was superior to the conventional methods of instruction with respect to students' academic achievement. This was because their quasi-experimental study revealed that students who learnt via concept mapping obtained significantly higher achievement scores

than those who were taught via the traditional teaching methods, as was done in the control groups of this study.

Concept mapping as an instructional strategy was also used to teach Chemistry, in a study by Singh and Moono, (2015), which involved 118 girls (59 in the experimental group and 59 in the control group). The control group was exposed conventional methods (lectures and discussion) while the experimental group was exposed to concept mapping, both for 25 days. However unlike the present study, Singh and Moono, (2015) used the mixed group intelligence test to collect data, which was analyzed using t-test. Their results revealed that achievement in Chemistry of the girls taught by concept mapping was significantly more as compared to those taught by the traditional lectures and discussion, which is in perfect agreement with the outcome of this study with respect to the first research objective.

Findings of this study are also in unison with those of Wilson and Kim, (2016); Boujaode and Attieh, (2008); Chee and Wong, (1996) and Otor, (2013). All these studies focused on the effect of concept mapping as the main intervention, on students' achievement in different subjects, using methodologies similar to those applied in the present study. They all established that students who were taught using concept maps obtained higher grades in respective topics and subjects as compared to those who were taught the same content by way of the conventional instructional approaches.

A similar study was carried out in India by Chawla and Singh, (2015), which investigated the effect of teaching through Concept Mapping on the achievement in Chemistry among girls. Sample of the study consisted of 118 girls of the IX class from two Government schools of Ludhiana city. Experimental group was exposed to Concept Mapping method and the controlled group was exposed to conventional method, which entailed lecture and discussion for twenty five days.

Mixed Group Intelligence Test (MGTI) was used to match the groups. An achievement test in Chemistry, which was developed and standardized by the investigator, was used as tool for data collection. Results of the t-test analysis of the gain scores showed that achievement in Chemistry of the girls taught by Concept Mapping was significantly more as compared to girls taught by conventional methods. It is noteworthy however that while Chawla and Singh, (2015) used girls' only for their study, while the present study used boys and girls, yielding similar results. Assuming that concept mapping would also have the same effect on male students would not be an idea too farfetched, going by these two studies that adopted different approaches.

4.6.3 Results of Objective Two

The second objective of this study was to determine the association between students' self-efficacy and achievement in electrochemistry when taught using SOCM and the CIS. Data concerning students' self-efficacy and their achievement in electrochemistry were collected by the SSEQ and the SEAT respectively. Both instruments were administered to the sampled students as per the research design. The second null hypothesis was formulated from this objective as follows;

H_{02} *There is no significant association between students' self-efficacy and achievement in electrochemistry when taught using SOCM and the CIS.*

This hypothesis was tested inferentially using bivariate Pearson's correlation in order to determine the direction and strength of association between the two variables in question. Results were as presented in Table 4.6.

Table 4.6: Correlation Coefficients of Posttest Achievement vs. Self-Efficacy

VARIABLE	ACHIEVEMENT	S.E	DESCRIPTIVES	
			MEAN	S.D
ACHIEVEMENT	-	0.228*	58.59	11.90
S.E	0.228*	-	71.79	9.894

* $p < 0.001, \alpha = 0.05$

As we can see from Table 4.6, there was a positive but weak association between students' post test self-efficacy and achievement scores [$r=.228, p<.001$ at $\alpha=.05$]. This is because the Pearson's correlation coefficient obtained is closer to zero than to 1, hence the description of the association as 'weak'. Furthermore, it can be observed from Table 4.6 that the sign of the correlation coefficient (r) is positive, which implies that a students' high self-efficacy score also translates to high achievement score and vice-versa. All these revelations are contrary to the assertion of the second null hypothesis, which was consequently rejected because empirical evidence arising from data collected by the SEAT and SSEQ suggested otherwise. It can alternately be asserted that there is a weak positive association between students' self-efficacy and their achievement in electrochemistry.

4.6.4 Discussion of Findings From the Second Objective/H₀₂

It was established that there was a weak positive association between students' achievement and self-efficacy scores in the posttest of this study. This association was statistically significant at the 0.05 alpha level, which was contrary to the assertion of the second null hypothesis of the study. The positive value of the correlation coefficient implies that a students' high self-efficacy score would lead to a high achievement score and vice-versa.

This association, though weak, is statistically significant because the p-value associated with the calculated correlation coefficient is less than the stipulated alpha value. These findings are similar to those of Aurah, (2013), whose mixed methods study revealed that there was a significant positive association between students' self-efficacy beliefs in Biology and their achievement in the subject. However, the association between self-efficacy beliefs in Biology was strong, unlike the findings of the present study.

Just like this study, a study by Goulao, (2014) examined the relationship between the academic self-efficacy of an adult learners group in an online learning context with their actual performance. The latter aimed at evaluating the relationship between self-concept of a group of students in online context and their academic achievement. Data were collected from 63 students of both genders, with average age of 42 years old, selected from the first years of their undergraduate studies. An adapted questionnaire was used to measure self-efficacy, whose data were analyzed using descriptive and inferential statistics. The Pearson correlation coefficient was used to determine the relationship between self-efficacy and academic performance.

The result indicated that students' level of self-efficacy was high and a significant relationship existed between self-efficacy and academic achievement ($r=0.286$, at 0.05 level), which is the same result that the current study obtained.

Also in support of findings of this study are results of another study by Tenaw, (2013) which investigated the relationships between self-efficacy and achievement for second year students in the fall of 2012 in Analytical Chemistry at Debre Markos College of Teacher Education. The self-efficacy survey and an achievement test were completed by 100 students. The self-efficacy survey data were gathered by Likert scale questionnaire. By using Pearson's correlation, the relationships between self-efficacy and achievement were determined. The results indicated that a significant weak positive relationship exists between self-efficacy and achievement, which is in perfect agreement with the findings of the present study.

Using the Children's Perceived Academic Self-Efficacy subscale from The Morgan-Jinks Student Efficacy Scale (MJSES), a study similar to the present one was conducted at Springfield Middle School by Taylor, (2014), which examined the correlation between students' self-efficacy level and their self-reported academic grades in English, math, science, and social studies.

Also, the correlation between above-grade-level students' self-efficacy and their self-reported grades was compared to those of general students. The sample included 56 middle school students from a suburban area in Williamsport, Maryland. Through the use of a Chi-square test of independence, the results indicated that regardless of class level, students' self-efficacy in math and science are related to

their grades in those subjects. These results seem to go in the same way as several other studies that lend support to the outcome of the present study, as they all found out a statistically significant relationship between students' academic achievement and self-efficacy (Bates and Khasawneh, 2007; Cascio, Botta and Anzaldi, 2013; Taipjutorus, Hansen and Brown, 2012).

Findings of this study are however in disagreement with those of Wilson and Kim, (2016), which investigated the effects of concept mapping on academic self-efficacy in a collaborative learning environment. Their study, which employed a randomized controlled pretest-posttest group research design to examine whether learning strategies such as concept mapping can help students with both reading comprehension and intrinsic motivation of wanting to master a task at a high level. Their results found a strong positive association between students' self efficacy beliefs and their achievement, unlike this study where the relationship was weak.

4.6.5 Results of Objective Three

The third research objective was to determine the extent to which students' experimental skills and attitude interact to influence their achievement in electrochemistry when taught using SOCM and the CIS. Data with respect to this objective were collected by the Students' Electrochemistry Achievement Test (SEAT), part B of the Students' Attitude and Motivation Questionnaire (SAMQ) and the Students' Experimental Skills Checklist (SESC). The third null hypothesis of this study was formulated from this objective as follows:

H₀₃: *Students' experimental skills and attitude do not significantly interact to influence achievement in electrochemistry when taught using SOCM and the CIS*

This hypothesis was tested using ANCOVA, whose results of the tests of between subjects' effects were as presented in Table 4.7.

Table 4.7: ANCOVA Tests of Between Subjects Effects

SOURCE	DF	F	P
Pretest Achievement	1	0.004	0.951
Posttest Attitude	50	2.533	0.001
Posttest Exp. Skills	46	1.435	0.109
Attitude * Exp. Skills	254	1.379	0.090

*interaction

As it can be seen from Table 4.7, an ANCOVA [between subjects factor: Posttest Achievement, covariate: Pretest achievement] revealed main effects of attitude [$F(50, 399)=2.533, p=.001$] and no main effects of experimental skills [$F(46, 399)=1.435, p=.109$] and no interaction between attitude and experimental skills, [$F(254, 399)=1.379, p=.09$ at $\alpha=.05$].

The non-significant p-value for the interaction implies that students with a positive attitude towards electrochemistry may indeed perform very well in the topic, regardless of how well they use their experimental skills. However, since a significant main effect of attitude was revealed, it implies that students with positive attitude towards electrochemistry may also perform well in the topic as compared to those with a negative attitude. In the same vein, the non-significant main effects of experimental skills imply that for a student to obtain high scores in electrochemistry,

they don't necessarily have to use their experimental skills correctly. All these inferential statistics provide evidence that supports the assertion of H_{03} . The third null hypothesis was consequently not rejected. It can therefore be posited that students' attitudes do not interact with their experimental skills to influence achievement in electrochemistry.

4.6.6 Discussion of Findings From the Third Objective/ H_{03}

Results from data collected from third objective of the study revealed that students' experimental skills and attitude do not interact to influence their achievement in electrochemistry. This was because the p-value obtained for the interaction was greater than 0.05, the stipulated alpha level.

In support of findings of this study are those from a study by Nwagbo and Chukelu, which investigated the effects of biology practical activities on secondary school students' process skill acquisition in Abuja Municipal Area Council. The design of the study was quasi-experimental; specifically the pretest-posttest non equivalent control group design. A sample of 111 senior secondary one biology students was randomly drawn from two coeducational schools and used for the study. The Science Process Skill Acquisition Test (SPSAT) was used to collect data, which were analyzed using mean, standard deviation and ANCOVA at the 0.05 level of significance. The results revealed that practical activity method was more effective in fostering students' acquisition of science process skills than the lecture method but there was no interaction between the variables in question.

These findings are in contrast to those of Otor, (2013), whose similar study that was carried out in Nigeria indicated a significant interaction between the variables in question. Ogundola *et al*, (2010) assessed the effect of constructivism instructional approach on teaching practical skills to mechanical related trade students in western Nigeria technical colleges. Elements of constructivism assessed were; concept mapping, cooperative work skills and cognitive apprenticeship.

A methodology similar to the one of the present study was applied. Their null hypothesis was also tested using ANCOVA, at 95% confidence level, whose results showed a significant interaction between the variables under investigation, contrary to the findings of this study with respect to the third research objective. It can however be noted that while the present study was grounded on Ausubel's (2000) Meaningful Learning Theory, that of Ogundola *et al* took a constructivist approach, which could be the reason why the two studies obtained conflicting findings.

Also in disagreement with findings of this study is the outcome of a cross-sectional study by Azodo, (2014), which analyzed the interaction between students' attitude and technical skills involved in a specific trade chosen among all the formal technical trainees of Don Bosco Technical Institute, Onitsha, Nigeria. A 24-item questionnaire, designed after critical examination and revision of some related studies and a combination of individual technical projects, sequence of job operation prepared by the students and written tests which cumulatively made up the school academic performance record in technical work, was used to assess students' attitude and performance respectively. Analysis of the data showed there was an

interaction between students' attitude and technical skill acquisition, which significantly influenced their performance.

A study by Lawal, 2015), which investigated the impact of practical activities on attitude, skills acquisition and performance in chemistry among colleges of education students, north-west zone of Nigeria also yielded findings that are not in unison with the present study. In the former, a randomized experimental-control groups design involving pretest and posttest was used for the study.

The population of the study comprised 1982 Chemistry students in 12 Colleges of Education in the North-West zone. Two Colleges of Education were randomly selected using balloting and grouped into Experimental and Control Groups using simple random sampling technique from the population 22 students were selected. Three research instruments' Students Attitude toward Chemistry Practical Questionnaire (SACPQ) with reliability coefficient of 0.67, Skills Acquisition Observation Check List (SAOCL) with reliability coefficient of 0.91 and Chemistry Performance Test (CPT) with reliability coefficient of 0.87 were validated by experts and used to collect data for the study.

Students in the experimental group were taught using practical activities while those in the control group were taught using lecture method. Three research questions were raised and answered using Mean Rank, Mean Rank Difference, Mean and Standard Deviation and three research hypotheses were formulated and tested using Kruskal-Wallis H, Tukey HSD test and t-test at 0.05 level of significance. Results

revealed an interaction between attitude and practical skills, which impacted positively on students' performance in Chemistry.

4.6.7 Results of Objective Four

The fourth objective of this study was to establish the extent to which learning indicators can predict students' achievement in electrochemistry when taught using SOCM and the CIS. These learning indicators included; students' self-efficacy beliefs, attitude, motivation and their experimental skills in electrochemistry. Data with respect to this objective were collected by the SEAT, SAMQ, SSEQ and the SESC. The fourth null hypothesis was formulated from this objective as follows:

H_{04} : *Learning indicators cannot predict students' achievement in electrochemistry when taught using SOCM and the CIS*

A Standard Multiple Linear Regression (SMLR) was performed on data collected with respect to the fourth objective and hypothesis to determine whether students' self-efficacy, attitude, motivation and experimental skills could predict their achievement in electrochemistry. The ANOVA test of the fitness of the regression model yielded affirmative results [$F(4, 395)=12.580, p<.001$ at $\alpha=.05$]. This outcome provided the green light to proceed with regression analysis on the data in question.

The model summary for the regression revealed that students' posttest attitude, motivation, self-efficacy and experimental skills' scores explained 11.3% of the variance in their posttest achievement scores. The "enter" method, which was used for this analysis revealed that students' posttest self-efficacy, attitude, motivation and experimental skills' scores explained a significant amount of variance in the values of the posttest achievement scores obtained [$F(4, 395) = 12.580, p < .001, R^2 = .113, R^2_{Adjusted} = .104$]. The eventual analysis results for the regression coefficients were as presented in Table 4.8, in which students' posttest achievement score was the dependent variable and posttest self-efficacy, attitude, motivation and experimental skills' scores as the predictor variables.

Table 4.8: Standard Multiple Linear Regression Analysis

Model	B	T	P	Descriptives	
				Mean	S.D
Constant	31.14	5.068	0.000		
S.E	0.062	0.871	0.384	71.79	9.894
Attitude	0.221	3.816	0.000	70.93	12.90
Motivation	0.123	2.003	0.046	70.96	10.25
Exp. Skills	-0.078	-1.333	0.183	70.03	9.666

Table 4.8 reveals that students' post test self-efficacy (S.E) scores did not significantly predict their achievement scores in electrochemistry [$\beta = .062, t(399) = .871, p = .384$]. Students' posttest experimental skills scores also did not significantly predict their achievement scores [$\beta = -.078, t(399) = -1.333, p = .183$]. However, it can be seen from Table 4.8 that students' posttest motivation scores significantly predicted their achievement scores in electrochemistry [$\beta = .123, t(399) = 2.003, p = .046$] and so did students' post test attitude scores [$\beta = .221, t(399) = 3.816, p < .001$].

After doing away with all the non-significant predictors of students' posttest achievement in the regression model, and including the constant term which was significant [$\beta=31.14$, $t(399)=5.068$, $p<.001$], a regression equation was formulated from the SMLR analysis as shown in Figure 4.1.

$$\text{Achievement score} = 31.14 + (0.221 \times \text{Attitude score}) + (0.123 \times \text{Motivation score})$$

Figure 4.1: Linear Regression Equation for Predicting Students' Achievement

(Source: Researcher)

Notably, experimental skills and self-efficacy scores are out of this regression equation in Figure 4.1 because they did not contribute significantly to the achievement scores as explained by the model summary. To exemplify the applicability of this equation, we can predict with 11.3% accuracy, a students' achievement score in electrochemistry given their attitude and motivation scores. For example, the posttest achievement score in electrochemistry for a student who has scored very low on attitude and motivation, with scores of say 20 and 25 respectively can be predicted by substituting them in the equation as follows:

$$\text{Achievement score} = 31.14 + (0.221 \times 20) + (0.123 \times 25) = 33.635$$

It can be seen from this working that a low achievement score of 33.635 is obtained as a result. Let us now consider another circumstance whereby a student scores relatively higher attitude and motivation scores of say 95 and 99 respectively. Their

posttest achievement score can be predicted using the same equation in Figure 4.1, also by substituting 95 and 99 in the regression equation as follows;

$$\textit{Achievement score} = 31.14 + (0.221 \times 95) + (0.123 \times 99) = 64.312$$

This working proves that a higher achievement score is obtained for the student who scores higher scores in the significant predictor variables, which were posttest attitude and motivation scores.

It is now apparent from all workings displayed in this section with respect to the linear regression equation in Figure 4.1, that there is enough evidence to a new assertion that though not all, some learning indicators can significantly predict students' academic achievement in electrochemistry. This new assertion partially disagrees with what is posited in the fourth null hypothesis of this study because self-efficacy and experimental skills cannot predict. For this reason, the fourth null hypothesis was rejected. It can now be alternately asserted that two learning indicators namely; students' attitude and motivational level can significantly predict their achievement in electrochemistry.

4.6.8 Discussion of Findings From the Fourth Objective/H₀₄

It was established that students' attitude and motivation scores could significantly predict their achievement scores in electrochemistry. Their experimental skills and self-efficacy scores however did not significantly predict achievement scores in this topic. These findings contradict those of a study by Charsky and Ressler, (2010), which investigated students' motivation to learn history concepts while playing a

commercial, off-the-shelf computer game, Civilization III. Their study examined the effect of using conceptual scaffolds to accompany game play. Students from three 9th grade classes were assigned to one of three groups; one used an expert generated concept map, another one constructed their own concept maps, while the control group used no concept maps. It was predicted that the use of concept maps would enhance the educational value of the game playing activity, in particular students' motivational levels; however, the opposite happened.

Students who used a concept maps showed lower motivation on the task relative to their baseline motivation for regular classroom instruction. In contrast, the levels of motivation in playing the game, for students in the control group, met or exceeded their levels of motivation during regular classroom instruction. These results suggested that using a conceptual scaffold can decrease students' motivation to learn classroom material through game play, perhaps because conceptual maps can (a) focus students' attention on the difficulty of learning the concepts and on the extrinsic rewards for playing the game and (b) make game play less autonomous, less creative, and less active (Charsky and Ressler, 2010). According to them, all of these can negate the primary property that provides playing its principal potential pedagogical power, which is fun.

With respect to self-efficacy, the findings of this study are in contrast with those of Ferla, Valcke, and Cai, (2009), who also carried out a similar study in Belgium but found out that Self-efficacy was a good predictor of students' academic achievement. However, these findings are in harmony with those of the current

study in the sense that in both studies, motivation was found to be a significant predictor of academic achievement.

Ferla *et al*, (2009) investigated whether academic self-efficacy and academic self-concept represent two conceptually and empirically distinct psychological constructs, when studied within the same domain. Their study, which was based on cognitive theories, revealed that (i) Mathematics self-efficacy and Mathematics self-concept do indeed represent conceptually and empirically different constructs, even when studied within the same domain, (ii) students' academic self-concept strongly influences their academic self-efficacy beliefs and (iii) academic self-concept is a better predictor and mediator for affective-motivational variables, with academic self-efficacy being the better predictor and mediator of academic achievement. Interestingly, these findings are in total disharmony with a similar study, which was carried out in Greece, using the same methodology.

The latter, which was carried out by Paraskeva, Bouta, and Papagianni, (2008), investigated the relationship between individual characteristics of secondary school teachers and computer self-efficacy, as well as teacher prospects with regard to modern technologies. Their second research question concerned the relationship between self-concept and computer self-efficacy, which ascertained that between the two variables there is no significant association. The current study therefore reconciles the two previously mentioned studies.

4.6.9 Results of Objective Five

The fifth and final objective of this study as outlined in chapter one of this work was to establish the differential effects of SOCM and the CIS on students' achievement in electrochemistry by gender and school type. Data with respect to this objective was collected by the SEAT. The fifth null hypothesis of this study was formulated from this objective as follows:

H_{05} : *There are no significant differential effects of SOCM and the CIS on students' achievement in electrochemistry by gender and school type*

This hypothesis was statistically tested using 2×1 factorial ANOVA, in which gender and school type were the fixed factors and posttest achievement score the dependent variable. Results of the tests of between subjects' effects were as presented in Table 4.9.

Table 4.9: 2×1 Factorial ANOVA on Posttest Achievement Scores

SOURCE	D.F	F	P
Gender	1	0.328	0.567
School Type	2	0.301	0.740
Gender * School Type	0	-	-

*Interaction

As it can be observed from Table 4.9, a 2×1 factorial ANOVA with gender (male, female) and school type (mixed, boys', girls') as the between subjects' factors

revealed no main effects of gender [$F(1, 398)=.328, p=.567$] and so was the case with school type [$F(2, 397)=.301, p=.740$]. These main effects were not qualified by in interaction between gender and school type. This implied that students' achievement in electrochemistry did not depend on whether or not they were male or female. It also did not matter whether or not they enrolled in co-educational (mixed) or single-gender schools. These findings are in total agreement with what H_{05} posited, prior to its statistical testing. As a result, the fifth null hypothesis of this study was accepted and the alternative hypothesis rejected. Going by the empirical evidence provided by data collected in this study, it can now be asserted that students' gender and type of school they are enrolled into do not play any significant role in determining the achievement scores they will obtain in electrochemistry.

4.6.10 Discussion of Findings From the Fifth Objective/ H_{05}

It was established from data collected with respect to the fifth objective and subsequent statistical testing of H_{05} that there were no differential effects of SOCM and the CIS on students' achievement in electrochemistry by both gender and school type. This was because the F-values obtained with respect to both gender and school type as grouping variables of the sampled students yielded non-significant p-values. Students' gender and school type are therefore not significant determinants of their academic achievement in electrochemistry.

These findings posit a divergent view to those of a similar study by Singh and Moono, (2015), which investigated the differential effects of concept mapping on Zambian students' achievement in selected chemistry topics at tertiary level. Their

true experimental study revealed significant differences in post test achievement scores between male and female students, with the latter outperforming the former, contrary to results of the present study. It is however worth noting that while the present study used a sample of 400 students, the Zambian study used a relatively smaller sample of 39 students. It is the current researcher's opinion that this difference in results of two studies that used similar methodologies, albeit in different countries, was as a result of the big difference in sample sizes used. Type II error might have been committed in the study by Singh and Moono, (2015) as a result of using a very small sample size.

Also contradictory to findings of the present study are results of another study by Meltem and Serap, (2004), which investigated gender differences in academic performance in a Turkish university. Theirs established that despite lower entrance scores and under-representation in most departments, female undergraduate students outperformed their male counterparts during their college years. Additionally, they noted that while it was true that higher grades in the Faculty of Education and the greater concentration of female students in education departments helped explain the higher grades for the female students, it was also true that female students outperformed their male counterparts in all the other four schools considered in their study. Their multivariate analysis further showed that controlling for all other relevant factors, belonging to a certain school did not bring about an advantage to female students.

Quite the contrary, it was the male students who enjoyed a 'grade premium'. However unlike the present study, Meltem and Serap, (2004) controlled for student ability and other relevant individual attributes and consequently, their results indicated that female students made better use of their individual endowments and all opportunities offered at their learning institutions in achieving higher grades. As suggested in their literature review, this entailed such factors as better class attendance and study skills, both of which were not part of the present study's variable list and this probably explains the difference in outcome between the present study and that by Meltem and Serap, (2004).

A recent study that seems to agree with findings of the present study is that by Ogonnaya, Okechukwu and Ugama, (2016), who investigated the effects of concept mapping on students' achievement in basic science. Their study, which was carried out in Ebonyi State of Nigeria employed a quasi experimental design, just like the present study. Their sample was 122 students, selected from two secondary schools drawn from the population through simple random sampling. One school was used for the intervention and the other as control.

The intervention involved teaching basic science with concept mapping approach. The control group on the other hand was taught with conventional methods. Mean, standard deviation and ANCOVA were used to analyze data. Results showed that concept mapping fosters students' achievement in basic science than conventional methods. Concept mapping also boosted the achievement of both male female students in the subject. In addition there was no interaction between gender and teaching methods on students' achievement in basic science.

A study by Odagboyi, (2015) examined the effect of gender on the achievement of students in Biology. The study utilized an intact class in which there were 39 males and 49 females. A Biology Achievement Test (BAT) was used for data collection and was not subjected to reliability assessment because it was standardized. The students sat for the BAT as pretest, and the results were collated by gender. A t- test analysis showed that there was no significant difference between the mean scores of boys and girls. The class was taught topics in microorganisms for 12 weeks and when the 12 weeks lapsed, the BAT was administered as posttest. Data were analyzed using t-test at the 0.05 level of significance and the outcome showed that the boys achieved significantly higher than the girls when taught using the Jigsaw method. Interestingly, the reason for this significant difference could not be arbitrarily conjectured. The study consequently pointed out:

“There would be a need to research more into other variables like grouping methods, group dynamics and to use other techniques of gathering data especially from girls to find out how they fared during the lessons. It will be nice to find out the effect of culture on the achievement of girls. If girls come to school with the cultural image created that boys are superior to girls, it might affect their zeal to learn” (Page 178)

The methodology of the present study, as presented in chapter three of this document, was therefore partly in response to the recommendations of the study by Odagboyi, (2015). With respect to school type, findings of the present study are in harmony with those of a study by Alimi, Ehinola and Alabi, (2012), who investigated the influence of school types on students’ academic performance in Ondo State, Nigeria. The latter was designed to find out whether facilities and students’ academic performance are related in private and public secondary schools

respectively. The study, which was based on descriptive survey design, used proportionate random sampling technique to select 50 schools. Data, which were collected using the Students' Academic Performance Questionnaire (SFDAPQ) for principals, was analyzed using t-test, which revealed no significant difference in academic performance of students in the two types of secondary schools.

However, contrary to these findings is a similar study by Okon and Archibong, (2015), which also examined the difference in academic achievement of students in both private and public secondary schools in Nigeria. Their sample size was 940 respondents drawn from both private and public schools. Ex-post facto design was used for this study and t-test analysis was adopted to analyze the data. It was found out that students in private secondary schools performed better in Social Studies than those in public schools.

It is now clear from the findings of the few studies highlighted in this discussion that even though plenty of research has been done to investigate the effect of gender and school type on students' academic achievement, there is no consensus as many of the findings are contradictory. This therefore begs for more research in different parts of the world, using various methodologies, other than those used in the prior studies, so as to strike a meaningful conclusion.

4.7 Qualitative Findings

Focus group interviews were conducted at the latter stages of this study to corroborate the findings from quantitative data. Some of the students who were interviewed expressed high levels of self-efficacy, attitude and motivation with

regard to items in the SEAT administered to them as achievement posttest. Transcripts from 3 randomly selected participants from the experimental group supported these themes, as they had this to say when they were asked to comment about the SEAT, electrochemistry as a topic, and the use of SOCM to teach it:

Student X: *“All questions in that test were from what we had learnt and I think I will get quite a good score. The concept mapping software we used also made it very easy for us to relate almost all concepts we learnt in electrochemistry on one page!” I’m very sure I will score good marks in all the questions I attempted.”*

Student Y: *“Some of the questions were tricky but not difficult in my opinion, especially because they were all from one topic of electrochemistry. Furthermore, I always drew concept maps at the back of my question paper and used them to remind myself of ideas that had slipped out of my mind....very interesting. I think I like this topic and method of tackling questions which is very timely. Generally, I think everyone will score higher marks.”*

Student Z: *“The concept maps that our teacher taught us how to draw were very helpful to me during my private study as I was able to relate several concepts learnt on a particular day, all on one big concept map, with so much ease! I was also able to connect some of the ideas I learnt in class with what I see in real life settings. A good example is the mobile phone batteries.... I now understand why they ‘die’ after a few days. As for that exam, let’s just say I enjoyed it. I don’t need to mention the grade here but I will pass for sure.”*

In the long run, the participants quoted obtained high self-efficacy, attitude and motivation scores when their completed SSEQ and SAMQ were retrieved and analyzed. [Self-efficacy: Student X = 86, Student Y = 84, Student Z = 82, Motivation: Student X = 82, Student Y = 95, Student Z = 95, Attitude: Student X = 89, Student Y = 92, Student Z = 95]. When all the SEAT scripts were later marked and scored,

those belonging to students X, Y and Z were retrieved and on observation, the achievement scores they obtained generally supported their verbal sentiments in the FGI [*Student X = 23/30, student Y = 27/30, Student Z = 26/30*].

When asked about the same subject during their turn for the FGI, most respondents in the control group were categorical about their expected scores in the SEAT, opining that most questions therein were tricky, challenging and needed cramming or good mathematical skills in order to for them to be tackled successfully. The transcripts that follow give a word-for-word account of three of the respondents.

Student P: *“You see the questions in this test were from only one topic, which was a big disadvantage for someone like me who had read widely. To be sincere though, I personally don’t like questions where you have to write stoichiometric equations, let alone balancing them, yet there were so many in this exam.”*

Student Q: *“Surely mwalimu, the questions were a bit challenging. Others looked simple at first, yet so tricky after reading again. Some of them needed someone who is good in Mathematics. There were also several questions about definition and stating..... which need cramming or revising about them daily, which may not be possible for some of us who have seven other subjects to prepare for”.*

Student R: *“I can’t really say whether I will pass or fail the test we did yesterday because you know most Chemistry questions are usually very unpredictable and the test we sat for yesterday was no exception. The questions you are sure you will get right may let you down at times”. To add on that, the topic of electrochemistry is very wide, which makes it difficult for one to prepare adequately because you can never be sure from which sub-topic the questions will come from. I also did not attempt questions 6 and 9 because they were very tricky.... more or less like Mathematics....which I’m not very good at. The other questions were less difficult”*

The three respondents obtained comparatively low self-efficacy, attitude and motivation scores when their completed SSEQ and SAMQ were later checked out [*Self-efficacy: Student P = 51, Student Q = 48, Student R = 55, Motivation: Student P = 55, Student Q = 49, Student R = 54, Attitude: Student P = 40, Student Q = 33, Student R = 26*]. Incidentally, the same students had comparatively lower achievement scores when their SEAT answer sheets were later retrieved and marked [*Student P = 12/30, Student Q = 10/30, Student R = 8/30*].

Three emergent themes that clearly stood out from all the ten focus group interviews, which were conducted one day after administration of the SEAT were; self-efficacy beliefs, attitude and motivational levels as summarized in Table 4.10.

Table 4.10: Summary of Emergent Themes From Focus Group Interviews

Theme	Code Words	Explanation of Theme
Self-efficacy	With regard to passing the SEAT: I'm sure, I'm confident, I know, No doubt, certainly and their antonyms	This theme depicts the level of self-efficacy beliefs expressed by the respondents. Most in SOCM group seemed confident they will do well in the test because it was narrow in scope while majority in the CIS group felt otherwise, citing scope of the SEAT as their major undoing.
Attitude	About their feelings towards chemistry and different aspects of learning it: Like, dislike, love, hate, impressive, fear	The words expressed by the interviewees were a clear indication of their liking or dislike for the test items, the topic of electrochemistry and the instructional strategies used.
Motivation	Interesting, relevant, satisfied, motivating, boring, meaningful, confident, attention,	Some of these words came out directly from the respondents' mouths, which indicated that most of the scores they obtained in the electrochemistry test, coupled by the use of SOCM reassured them of a very successful Chemistry course in the long run.

4.8 Effect Size

With significant main effects of SOCM on students' achievement scores in electrochemistry, Cohen's *d* was computed to determine the magnitude of differences that were observed between the experimental and control groups of this study. Cohen's rules of the thumb for effect size, as outlined in Kelley and Preacher,

(2012), are as follows: Cohen's $d \leq 0.20$ is considered "small", Cohen's $d \leq 0.50$ as "moderate" while Cohen's $d \leq 0.80$ is considered "large".

$$d = \frac{\bar{x}_1 + \bar{x}_2}{s.d (pooled)}$$

Figure 4.2: Formula that was used to Calculate Effect Size

(Source: Kelley and Preacher, 2012)

By substituting in the formula displayed in Figure 4.2, the values of the mean of the experimental group (\bar{x}_1), that of the control group (\bar{x}_2), and the pooled standard deviation i.e. the standard deviation of the entire group as appearing in Table 4.2, effect size of the difference in this study's posttest achievement mean scores was computed, which yielded 0.719 as the value of Cohen's d .

This effect size can therefore be described as "large", hence very substantial, going by Cohen's guidelines as earlier stated. This is attributed by the researcher to the treatment that all the experimental groups of the study received, which entailed daily use of SOCM for teaching, learning and revision of all concepts learnt in the topic of electrochemistry. This should therefore as a matter of fact, sound a bell to all stakeholders in the Kenyan education sector that the solution to current students' low achievement in Chemistry, especially in abstract Chemistry concepts could now be here with us, going by the empirical evidence provided by data that were collected in this study.

CHAPTER FIVE:

SUMMARY, CONCLUSIONS AND RECOMMENDATIONS

5.1 Main Highlights of Chapter Five

This chapter presents a brief summary of the entire study, a summary of the findings, conclusions made from the research findings, the researcher's recommendations and finally, the suggestions for further research.

5.2 Summary of the Study

This study was instigated by the urgent need for effective strategies in the teaching and learning of difficult and abstract Chemistry concepts, whose lack thereof has occasioned dismal performance by students in the subject nationally for the last five consecutive years. The purpose of this study therefore was to find out whether the use of Software-Oriented Concept Mapping as an instructional strategy is more effective than the use of Conventional Instructional Strategies, with respect to academic performance in the abstract topic of electrochemistry, among secondary school students in Kakamega County, Kenya.

Five objectives guided this study. These were; (i) to determine whether there is a difference in achievement between students taught electrochemistry using SOCM and those taught via the CIS, (ii) to determine the association between students' self-efficacy and achievement in electrochemistry when taught using SOCM and the CIS, (iii) to determine the extent to which students' experimental skills and attitude interact to influence their achievement in electrochemistry when taught using SOCM and the CIS, (iv) to establish the extent to which learning indicators could predict

students' achievement in electrochemistry when taught using SOCM and the CIS (v) to establish the differential effects of SOCM and the CIS on students' achievement in electrochemistry by gender and school type.

The following five null hypotheses were formulated from these objectives and tested statistically at the 0.05 alpha level of statistical significance;

- H₀₁ There is no significant difference in achievement between students taught electrochemistry using SOCM and those taught via the CIS
- H₀₂ There is no significant association between students' self-efficacy and achievement in electrochemistry when taught using SOCM and the CIS
- H₀₃ Students' experimental skills and attitude do not significantly interact to influence achievement in electrochemistry when taught using SOCM and the CIS
- H₀₄ Learning indicators cannot predict students' achievement in electrochemistry when taught using SOCM and the CIS
- H₀₅ There are no significant differential effects of SOCM and the CIS on students' achievement in electrochemistry by gender and school type

The study was based on the Meaningful Learning Theory, and was implemented through a sequential mixed methods approach, thereby yielding both quantitative and qualitative data in that order. Quasi-experimental research design, using non-randomized pretest-posttest control group design was adopted to implement the quantitative phase of the study, while focus group interviews were adopted for the qualitative phase. Target population was 4,000 form four students and 30 Chemistry

teachers from secondary schools in Kakamega County, which offer computer studies as an examinable subject.

A sample of 400 students and 10 teachers was selected by multi-stage sampling procedure, through a combination of purposive, proportionate stratified and simple random sampling techniques. The independent variable was instructional strategy at two levels; Software-Oriented Concept Mapping (SOCM) and the Conventional Instructional Strategies (CIS), while the dependent variable was academic performance at five levels; Self-Efficacy, Attitude, Motivation, Experimental Skills and Achievement, while the dependent variable was Academic Achievement. Students' Gender and School Type on the other hand were the intervening variables. The study was piloted two weeks to the actual study in two secondary schools within Kakamega County, which offer computer studies. Observation check lists, questionnaires, focus group interview guides and achievement tests were used to collect raw data.

Reliability of these instruments was assessed using data from the pilot study, via the internal consistency alpha coefficients method, while their validity was established at the same stage, using the Rasch Model. Frequencies, percentages, mean and standard deviation were employed to analyze the raw data descriptively, while 2×1 factorial ANOVA, one-way ANOVA, ANCOVA, bivariate Pearson's Correlation and Standard Multiple Linear Regression were employed to test the null hypotheses at 0.05 α -level of statistical significance. Qualitative data were collected from focus group interviews and analyzed in themes as each emerged.

5.3 Summary of the Findings

From the five objectives of this study, it was found out that;

- i) There was a significant difference in achievement between students who were taught electrochemistry by SOCM and those taught via the CIS in favor of the former
- ii) There was a weak positive but significant association between students' self-efficacy and their achievement in electrochemistry after being taught using SOCM and the CIS
- iii) Students' achievement in electrochemistry was not influenced by the interaction between their attitude and experimental skills after being taught using SOCM and the CIS
- iv) Students' attitude and motivation were good predictors of their achievement scores in electrochemistry after being taught using SOCM and the CIS but self-efficacy and experimental skills were not
- v) SOCM and CIS had no significant differential effects on students' achievement in electrochemistry by gender and school type

5.4 Conclusions From the Main Research Findings

On the basis of empirical evidence arising from data that were collected in this study's quasi experiment and the subsequent focus group interviews, five major conclusions have been arrived at: -

First, students who are taught electrochemistry through the use of Software-Oriented Concept Mapping are likely to obtain significantly higher achievement scores in the topic as compared to those who are taught the same topic via the Conventional Instructional Strategies.

Second, students' with low self-efficacy beliefs in electrochemistry might consequently fail their achievement tests if question items are only from this topic, while those with high self-efficacy beliefs might consequently obtain high achievement marks in this topical test. Therefore the higher the self-efficacy, the higher the achievement in electrochemistry, as it has been found out.

Third, students with positive attitude towards electrochemistry may obtain low achievement scores in the topic, even if they use their experimental skills very well. The contrary can also be said for students with negative attitudes, because achievement in electrochemistry is not influenced by the interaction between experimental skills and attitude, as it has been found out in this study.

Four, if students' attitude and motivation scores in electrochemistry are known, it is possible to predict the scores they might get in the topics' achievement test, using the linear regression equation that this study has come up with. However, the same does not apply to students' scores in self-efficacy and experimental skills. This is because as the study has found out, attitude and motivation are good predictors of academic achievement, while self-efficacy and experimental skills are not.

Five, the academic achievement of male students might be similar to that of their female counterparts when both are taught using SOCM and the CIS. Furthermore the mean scores of mixed, girls' and boys' schools in electrochemistry tests might also be similar. This is because it has been found out that students' gender and school type are not contributory factors of their academic achievement. The findings of this study revealed a significant positive effect of SOCM on students' academic performance in the abstract Chemistry topic of Electrochemistry. As a special contribution to existing knowledge, this study therefore proposes the following model that can be adopted to improve academic performance in all abstract Chemistry as was shown by the results of the quasi experiment which was carried out in this study. This model, as illustrated in Figure 5.1 if well executed could certainly lead to attainment of National goals of Chemistry education, going by the empirical evidence from the data obtained in this study.

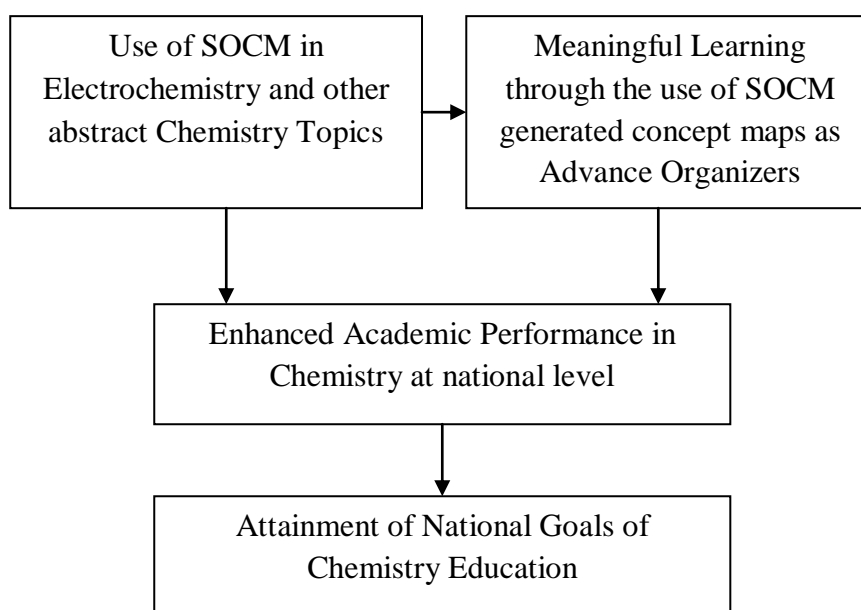

Figure 5.1: Model Postulating how SOCM can be used to Improve Performance

(Source: Researcher)

In retrospect, the attainment of these national goals had stalled prior to this study, due the persistent problem of dismal academic performance in chemistry for the last ten years.

5.5 Implications of the Findings

The study found a significant positive effect of SOCM on students' academic performance in the abstract topic of electrochemistry. This is a very important milestone that has several implications for instructional practice.

First, SOCM as an instructional strategy that leads to a positive attitude and high motivation among students should be adopted in all areas of Chemistry in which students have a negative attitude and low motivation, especially problems that involve or require plenty of Mathematical skills. Chemistry teachers should therefore focus on the specific Mathematical skills that are of interest in the Chemistry context and possibly generate concept maps that can specifically help the students to acquire and effectively use the said mathematical skills for them to have maximum impact on the abstract chemistry topics.

Secondly, the qualitative findings of this study revealed that a good number of students have weak mathematical skills, which in turn led to them having low self-efficacy when on questions in Chemistry that involved calculations. This therefore calls for Chemistry teachers to also be well equipped with sufficient Mathematical skills that can help them effectively teach all the mathematical Chemistry concepts in the curriculum. It is therefore imperative that a unit be introduced at university level, specifically designed for trainee Chemistry teachers, whose other subject

combination is not Mathematics, so that they can be taught all the mathematical skills required to solve all the Chemistry problems at secondary school level that involve calculations. The unit could be called “Mathematics for Chemistry”.

5.6 Recommendations From the Study

As it has been found out in this study, the difference in academic performance between students who were taught electrochemistry using Software-Oriented Concept Mapping and those who were taught using the Conventional Instructional Strategies was significant. Since the value of Cohen’s “d” for effect size as explained in chapter four of this work was found to be large, it implies that the difference in effectiveness between the two instructional strategies is substantial. It is on the basis such an effect size, that several recommendations are hereby made to key stakeholders in the education sector, for purposes of policy action. This is especially so because their implications directly concern the problem that necessitated this study in the first place.

5.6.1 Recommendations for Policy Makers in the Kenyan Education Sector

The findings from this study have implications for policy makers. Curriculum planners need to develop a greater awareness and understanding of the various variables that significantly predict achievement among high school students, and thus integrate them into the existing curriculum, like it was the case with students’ attitude, motivation and self-efficacy in the present study. Findings of this study therefore have important implications for concept mapping as an instructional strategy. To design a secondary school curriculum that aims to churn out high achievers in science subjects, knowledge of how self-efficacy, attitude and

motivation of students in abstract topics can be enhanced is very crucial because these are the key learning indicators.

5.6.2 Recommendations for Teachers of STEM

Teachers of Science, Technology, Engineering and Mathematics (STEM) should consider incorporating SOCM and other novel metacognitive instructional strategies into their daily teaching, as a means to foster students' performance in their respective subjects. Furthermore, science teachers should consider explicitly integrating the use of SOCM as an assessment strategy to supplement the traditional continuous assessment tests.

Science teachers should recognize the important role of such metacognitive assessment strategies, as they can bring the best out of their learners by detection and diagnosis of misconceptions from their incorrectly drawn concept maps. There is therefore need for formative assessment or evaluation using SOCM as this is a milestone that cannot be realized easily through the traditional assessment methods currently being used by STEM teachers in the country. This is especially so because an elaborately drawn concept map can easily inform a teacher of the presence and extent to which an idea has been misconceived.

5.6.3 Recommendations for Secondary School Students

Limitations aside, results of this study emphasize the importance of learners' attitude and motivation in the course of learning abstract concepts. Persistent encouragement and monitoring are therefore very important measures, because they ensure students

are fully aware and in control of their academic performance. According to the basic tenets of the Meaningful Learning Theory, as students build new ideas on the concepts they already know, meaningful learning takes place, which means that well constructed concept maps at the beginning of an abstract topic forms the basis of understanding all other concepts therein, however difficult they may first seem.

The most successful students are those with strong metacognitive skills, who monitor and evaluate their performance, and have confidence in their abilities to perform well. However, not all students may spontaneously engage in effective concept map construction and therefore, those who find it difficult from the onset should maintain close contact with their teachers, since SOCM is meant to supplement and not replace the teacher's role in instruction.

Findings of this study also lend support to the use of SOCM by students, for revising concepts that have been taught earlier, during their private study sessions, as it enhances their attitude and motivation, which as it has been laid bare in this study, are good predictors of their academic achievement. Providing high school students with opportunities to learn abstract concepts by SOCM can enable them to develop in-depth understanding of abstract concepts. To progress from novice to expert concept mappers, high school students must constantly seek feedback from their friends or teachers, all of whom they should engage to help them assess all the concept maps they draw. This way, the influential association between their self-efficacy, attitude, motivation and achievement in all the abstract topics would undoubtedly continue to flourish, for the betterment of their performance in Sciences.

5.7 Suggestions for Further Research

It was not possible to investigate all factors that affect students' performance in Chemistry because of several limitations like time, resources and scope of the study. However, with regard to research on the challenges currently facing the teaching and learning of Chemistry in the country, many gaps will still exist, even after adoption of all recommendations of the present study. For this reason, the following suggestions are hereby made for further research, with the hope of bridging some, if not all the gaps that this study leaves behind;

- i) For technical reasons, this study was done in only 10 schools within the research area, which have computer laboratories. Generalizing the findings of this study to the whole country would therefore be a farfetched idea. It is therefore suggested that a similar study be replicated in other counties within the republic of Kenya apart from Kakamega county, so as to ascertain if findings of this study are universal,
- ii) This study used SOCM in only one abstract topic in Chemistry, which was electrochemistry. However, there are many other abstract topics in the same subject, and also in other sciences. The use of SOCM should be tried in Biology and Physics also, so as to ascertain its effectiveness in different aspects of learning, in an effort mitigate the problem of poor performance generally facing Science education in the country,
- iii) There was no significant interaction between students' experimental skills and attitude, with respect to academic achievement in electrochemistry as it was found out in this study. However, there are many other aspects of learning that affect students' academic achievement, yet their interaction was

not investigated. A similar study should therefore be replicated to determine whether there are other combinations of learning indicators, whose interaction might significantly impact on students' academic achievement in science e.g. motivation/experimental skills, self-efficacy/motivation, motivation/attitude and experimental skills/self-efficacy, just to name but a few.

REFERENCES

- Akana, K. & Yamauchi, H. (2004). Task Performance and Metacognitive Experiences in Problem-Solving. *Psychological Reports, 94* (2), 715-722.
- Alimi, O.S., Ehinola, G.B. & Alabi, F.O. (2012). School Types, Facilities and Academic Performance of Students in Senior Secondary Schools in Ondo State, Nigeria. *International Education Studies, 5* (3), 44-48
- Aurah, M.C. (2013). The Effects of Self-Efficacy Beliefs and Metacognition on Academic Performance: A Mixed Method Study. *American journal of Educational Research, 1* (8), 334-343
- Ausubel, D.P. (2000). *The Acquisition and Retention of Knowledge: A Cognitive View*. Dordrecht: Kluwer Academic Publishers
- Aziz, A.A. (2010). *Rasch Model Fundamentals: Scale Construct and Measurement Structure*. Kuala Lumpur: Integrated Advanced Planning
- Azodo, A.P. (2014). Attitude Influence on Performance in Technical Skill Acquisition among Formal Technical Trainees. *International Journal of Research Studies in Education, 3* (5), 103 - 112
- Bailey, R.A. (2008). Design of Comparative Experiments. *Journal of the Royal Statistical Society: Series A General, 111* (3), 181-211
- Bamidele, E.F., Adetunji, A.A., Awodele, B.A. & Irinoye, J. (2013). Attitudes of Nigerian Secondary School Chemistry Students Towards Concept Mapping Strategies in Learning the Mole Concept. *Academic Journal of Interdisciplinary Studies, 2* (2), 475-484, ISSN: 2281-3993

- Barany, I. & Van, V. (2007). "Central Limit Theorems for Gaussian Polytopes":
Annals of Probability, 35(4), 1593 - 1621
- Bates, R. & Khasawneh, S. 2007. Self-efficacy and College students' Perceptions and Use of Online Learning Systems. *Computers in Human Behavior*, 23, 175-191
- Beck, R. (2009). *The Three R's Plus: What Today's Schools are Trying to Do and Why*. Minnesota: University of Minnesota Press.
- Bell, R.L. (2017). *The Theory Underlying Concept Maps and how to Construct Them*. Charlottesville: University of Virginia
- Boujaoude, S. & Attieh, M. (2008). The Effect of Using Concept Maps as Study Tools on Achievement in Chemistry. *Eurasia Journal of Mathematics, Science and Technology Education*, 4 (3), 233-246. Available at <http://www.ejmste.com>
- Canas, A.J. Coffey, J.W., Carnot, M., Feltovich, P., Hoffman, R.P., Feltovich, J.F. & Novak, J.D. (2003). A Summary of Literature Pertaining to the Use of Concept Mapping Techniques and Technologies for Education and Performance Support. *The Institute for Human and Machine Cognition*. Available at www.ihmc.us
- Cascio M., Botta V. & Anzaldi V. (2013). The Role of Self-Efficacy and Internal Locus of Control in Online Learning. *Journal of e-Learning and Knowledge Society*, 9 (3), 95 -106

- Charsky, D. & Ressler, W. (2010). "Games are Made for Fun": Lessons on the Effects of Concept Maps in the Classroom Use of Computer Games. *Computers and Education*, 56 (2011), 604-615
- Chawla, J. & Singh, G. (2015). Effect of Concept Mapping Strategy on Achievement in Chemistry among IX Grader Girls. *International Journal of Informative & Futuristic Research*, 3 (3), 1036-1044
- Chee, T.S. & Wong, P. (1996). *The Effects of Incorporating Concept Mapping Into Computer-Assisted Instruction*. A Paper Presented at the ERA/AARE Joint Conference, Singapore Polytechnic, 27th November
- Cheema, A.B. & Mirza, M.S. (2013). Effect of Concept Mapping On Students' Academic Achievement. *Journal of Research and Reflections in Education*, 7 (2), 125-132. Available at <http://www.ue.edu.pk/jrre>
- Chion, C. (2015). The Comparative Effect of Computer-Assisted and Paper-and-Pencil Concept Mapping on Learning Motivation and Achievement. *International Journal of Information and Education Technology*, 5(9), 668-690
- Chularut, P. & DeBacker, T.K. (2004). The Influence of Concept Mapping on Achievement, Self-Regulation, and Self-Efficacy in Students of English as a Second Language. *Contemporary Educational Psychology*, 29 (3), 248-263. Available at <http://www.sciencedirect.com>
- Coutinho, S.A. (2006). The Relationship Between the Need for Cognition, Metacognition, and Intellectual Task Performance. *Educational Research and Reviews*, 1 (5), 162-164

- Cox, D.R. (2006). *Principles of Statistical Inference*. Cambridge: Cambridge University Press
- Creswell, J.W. & Plano, C. (2011). *Designing and Conducting Mixed Methods Research*. Los Angeles, CA: Sage
- Delice, A. (2010). The Sampling Issues in Quantitative Research. *Education Sciences: Theory and Practice*, 10 (4), 2001-2018
- DeRue, S. (2012). "A Quasi-Experimental Study of After-Event Reviews". *Journal of Applied Psychology*, 97 (5), 681-689
- Dimitrios, B., Labros, S., Kakkos, N., Koutiva, M. & Koustelios, A. (2013). Traditional Teaching Methods Vs Teaching Through the Application of ICT in the Accounting Field: Quo Vadis?. *European Scientific Journal*, 9 (28), 73-101.
- Fan, W. & Yan, Z. (2010). Factors Affecting Response Rate in Web Survey: A Systematic View. *Computers in Human Behavior*, 26(2), 132-139
- Ferla, J., Valcke, M. & Cai, Y. (2009). Academic Self-Efficacy and Academic Self-Concept: Reconsidering Structural Relationships. *Learning and Individual Differences*, 19 (4), 499-505
- Fredericks, A.D. (2005). *The Complete Idiot's Guide to Success as a Teacher*. New York: Penguin Group
- Gelman, A. (2008). "Variance Analysis of": *The New Palgrave Dictionary of Economics*. (2nd Edition). New York: Palgrave Macmillan.

- George, D. & Mallery, P. (2003). *SPSS for Windows Step by Step: A Simple Guide and Reference. 11.0 Update. (4th Edition)*. Boston: Allyn & Bacon.
- Goulao, M.F. (2014). The Relationship between Self-Efficacy and Academic Achievement in Adults' Learners. *Athens Journal of Education, 1 (3)*, 238-246
- Green, S.B. & Salkind, N.J. (2011). *Using SPSS for Windows and Macintosh: Analyzing and Understanding Data. (6th Edition)*. New Jersey: Prentice Hall
- Guest, G. (2013). Describing Mixed Methods Research: An Alternative to Topologies. *Journal of Mixed Methods Research, 7 (2)*, 141-151
- Gwilym, P. (2017). "Heteroscedasticity: Testing and Correcting in SPSS" (PDF). pp. 12-18. Retrieved 2nd April 2017
- Haghighat, M., Abdel-Mottaleb, M. & Alhalabi, W. (2016). Discriminant Correlation Analysis: Real-Time Feature Level Fusion for Multimodal Biometric Recognition. *IEEE Transactions on Information Forensics and Security, 11 (9)*, 1984-1996
- Hendry, G.D & King, R.C. (1994). On Theory of Learning and Knowledge: Educational Implications of Advances in Neuroscience. *Science Education, 78 (3)*, 223-253
- Howell, D.C. (2009). *Statistical Methods for Psychology. (7th Edition)*. Belmont: Cengage Wadsworth

- Hwang, G.J., Wu, C.H. & Kuo, F.R. (2013). Effects of Touch Technology-Based Concept Mapping on Students' Learning Attitudes and Perceptions. *Educational Technology and Society*, 16 (3), 274-285.
- Iftekhar, H. (2013). Status of Secondary School Science Education. *Excellence International Journal of Education and Research*, 1 (4), 286-289.
- Ijsmi, E. (2017). "Application of Quantile Regression in Clinical Research: An Overview with the Help of R and SAS Statistical Package." *International Journal of Statistics and Medical Informatics*, 2 (1), 1-6
- Jones, B.D. (2009). Motivating students to engage in learning: The MUSIC Model of academic motivation. *International Journal of Teaching and Learning in Higher Education*, 21 (3), 272-285.
- Jones, B.D., Ruff, C., Snyder, J.D., Petrich, B. & Koonce, C. (2012). The Effects of Mind Mapping Activities on Students' Motivation. *International Journal for the Scholarship of Teaching and Learning*, 6 (1), 1-21
- Kahn, J.V. & Best, J.W. (1998). *Research in Education*. (8th Edition). Boston: Allyn and Bacon Publishers.
- Karakuyu, Y. (2010). The Effect of Concept Mapping on Attitude and Achievement in a Physics Course. *International Journal of the Physical Sciences*, 5 (6), 724-737
- Keller, J.M. (2010). *Motivational Design for Learning and Performance: The ARCS Model Approach*. New York: Springer

- Kelley, K. & Preacher, K.J. (2012). "On Effect Size". *Psychological Methods*, 17(2), 137-152
- Khajavi, Y. & Ketabi, S. (2012). Influencing EFL Learners' Reading Comprehension and Self-Efficacy Beliefs: The Effect of Concept Mapping Strategy. *Porta Linguarum*, 17, 9-27, ISSN: 1697-7467
- Khoshsima, H., Saed, A. & Hakimzade, A. (2016). Effectiveness of Concept Mapping Strategy on EFL Learners' Attitude and Gender Difference Outcomes in Vocabulary Acquisition. *International Journal of Humanities and Cultural Studies*, 3 (1), 640-656
- KICD, (2002). *The Kenya Secondary School Syllabus*. Nairobi: Kenya Institute of Curriculum Development.
- KNEC. (2014). *The 2013 KCSE Report*. Nairobi: Kenya National Examinations Council. Available at www.knec.go.ke, accessed on 13th May
- KNEC. (2016). *The 2015 KCSE Report*. Nairobi: Kenya National Examinations Council. Available at www.knec.go.ke, accessed on 15th April
- Kostova, Z. & Radoynovska, B. (2010). Motivating Students' Learning Using Word Association Test and Concept Maps. *Bulgarian Journal of Science and Education Policy*, 4 (1), 62-98
- Kutner, M.H., Nachtsheim, C.J. & Neter, J. (2004). *Applied Linear Regression Models*. (4th Edition). Irwin: McGraw Hill

- Lawal, M.H. (2015). *Impact of Practical Activities on Attitude, Skills Acquisition and Performance in Chemistry among Colleges of Education Students in North-West Zone, Nigeria*. A Masters Dissertation Submitted to the School of Postgraduate Studies, Ahmadu Bello University, Nigeria
- Long-Crowell, E. (2015). The Halo Effect: Definition, Advantages and Disadvantages. *Psychology 104: Socialpsychology.study.com*. Retrieved July 2016
- Markow, P.G. & Lonning, R.A. (1998). Usefulness of Concept Maps in College Chemistry Laboratories: Students' Attitudes and Effects on Achievement. *Journal of Research in Science Teaching, 35 (9), 1015-1029*
- Marno, V. (2012). *A Guide to Modern Econometrics*. (4th Edition). Chichester: John Wiley and Sons
- Martin, D.I (1994). Concept Mapping as an Aid to Lesson Planning: A Longitudinal Study. *Journal of Elementary Science Education, 6 (2), 11-30*
- Masinde, J.W., Wanjala, M. & Michieka, R. (2015). Effect of Programmed Instruction on Students' Attitude Towards Structure of the Atom and the Periodic Table among Kenyan Secondary Schools. *Science Education International, 26 (4), 488-500*
- Meltem, D. & Serap, T. (2004). Gender Differences in Academic Performance in a Large Public University in Turkey. *ERC Working Papers in Economics 04/17*
- Miller, G.A. & Chapman, J.P. (2011). Misunderstanding Analysis of Covariance. *Journal of Abnormal Psychology, 110 (1), 40-48*

- MoE, (2015). Ministerial Speech on the 2014 KCSE Results. Available at www.moest.go.ke, accessed on 1st June
- Moreno, M., Jelenchick, L. & Christiakis, D. (2013). “Problematic Internet Use among Other Adolescents: A Conceptual Framework”. *Computers in Human Behaviour*, 29 (4), 1879-1887.
- Nbina, J.B. & Viko, B. (2010). Effect of Instruction in Metacognitive Self-Assessment Strategy on Chemistry Students Self-efficacy and Achievement. *Academia Arena*, 2 (11), 1-10
- Nelson, D.B. (2007). *Academic Concept Mapping (ACM): A Critical Thinking Tool In Academic Advising For Improving Academic Performance In College Freshmen*. PhD Dissertation-Louisiana State University. Available at etd.lsu.edu/docs/06262007-190651
- Nicolic, D. (2012). Non-Parametric Detection of Temporal Order across Pair wise Measurements of Time Delays. *Journal of Computational Neuroscience*, 22 (1), 5-19
- Nicolic, D., Muresan, R.C. Feng, W. & Singer, W. (2012). “Scaled Correlation Analysis: A Better Way to Compute a Cross-Correlogram”. *European Journal of Neuroscience*, 1-21
- Nietfeld, J.L., Cao, L. & Osborne, J.W. (2005). Metacognitive Monitoring Accuracy and Student Performance in the Classroom. *Journal of Experimental Education*, 74 (1), 7-28.
- Njue, A.K., Kamau, L.M., & Mwanja, J. (2018). *Journal of Research and Method in Education*, 8(1), 18-23

- Nobahar, B., Tabrizi, A.R.N. & Shaghaghi, M. (2013). The Effect of Concept Mapping on Iranian Intermediate EFL Learners' Self-efficacy and Expository Writing Accuracy. *Theory and Practice in Language Studies*, 3 (11), 1799-2591, ISSN: 2117-2127
- Novak, J.D. (2010a). Learning, Creating and Using Knowledge: Concept Maps as Facilitative Tools in Schools and Corporations. *Journal of e-Learning and Knowledge Society*, 6 (3), 21-30
- Novak, J.D. (2010b). *Learning, Creating and Using Knowledge: Concept Maps as Facilitative Tools in Schools and Corporations*. New York: Routledge
- Novak, J.D. (2011). A Theory of Education: Meaningful Learning Underlies the Constructive Integration of Thinking, Feeling and Acting Leading to Empowerment for Commitment and Responsibility. *Meaningful Learning Review*, 1 (2), 1-14
- Nwagbo, C. & Chukelu, U.C. *Effects of Biology Practical Activities on Students' Process Skill Acquisition*
- Odagboyi, I.A. (2015). The Effect of Gender on the Achievement of Students in Biology Using the Jigsaw Method. *Journal of Education and Practice*, 6 (17), 176 - 179
- Ogonnaya, U.P., Okechukwu, G.O. & Ugama, A. (2016). Effects of Concept Mapping Instruction Approach on Students' Achievement in Basic Science. *Journal of Education and Practice* , 7(8), 79-84

- Ogundola, I.P., Abiodun, A.P. & Oke, J.O. (2010). Effect of Constructivism Instructional Approach on Teaching Practical Skills to Mechanical Related Trade Students in Western Nigeria Technical Colleges. *International NGO Journal*, 5 (3), 59-64, ISSN: 1993-8225
- Okon, C.E. & Archibong, U.I. (2015). School Type and Students' Academic Performance in Social Studies in Junior Secondary Certificate Examination. *Academic Journal of Interdisciplinary Studies*, 4 (2), 421 - 426
- Otor, E.M. (2013). Effects of Concept Mapping Strategy on Students' Achievement in Difficult Chemistry Concepts. *Educational Research*, 4 (2), 182-189, ISSN: 2141-5161
- Padma, T.V. (2015). India: The Fight to Become a Science Superpower. *International Weekly Journal of Science*, 521 (7551), 144-147
- Paraskeva, F., Bouta, H. & Papagianni, A. (2008). Individual Characteristics and Computer Self-Efficacy in Secondary Education Teachers to Integrate Technology in Educational Practice. *Computers and Education*, 50, 1084-1091. Available at <http://www.elsevier.com/locate/compedu>
- Pearl, J. (2015). Generalizing Experimental Findings. *Journal of Causal Inference*, 3 (2), 259-266
- Peters, G.J. (2014). The Alpha and Omega of Reliability and Validity: Why and how to Abandon Cronbach's Alpha and the Route Towards More Comprehensive Assessment of Scale Quality. *Europeans Health Psychologist*, 16 (2), 56-60
- Piers, S. (2012). *Motivation: Theory and Applied*. Boston, MA: Pearson Learning Solutions

- Ravitch, S.M. & Riggan, J.M. (2012). *Reason and rigor: How Conceptual Frameworks Guide Research*. Thousand Oaks, CA: Sage
- Riga, A. (2015). Investigating the Impact of Concept Mapping Software on Greek Students with Attention Deficit. *International Journal of Education and Development Using Information and Communication Technology*, 11 (3), 37-49
- Schunk, D. (2006). *Learning Theories: An Educational Perspective*. New York: Prentice Hall
- Shadish, R.W., Cook, T.D. & Campbell, D.T. (2002). *Experimental and Quasi-Experimental Research Designs for Generalized Causal Inference*. Boston: Houghton Mifflin
- Sharma, R. & Bhandari, R. (2013). "Skewness, Kurtosis and Newton's Inequality". *Rocky Mountain Journal of Mathematics*, 45 (50), 1639-1643
- Shihusa, H. & Keraro, F.N. (2009). Using Advance Organizers to Enhance Students' Motivation in Learning Biology. *Eurasia Journal of Mathematics, Science and Technology Education*, 5 (4), 413-420. Available at <http://www.ejmste.com>
- Singh, S.I. & Moono, K. (2015). The Effect of Using Concept Maps on Student Achievement in Selected Topics in Chemistry at Tertiary Level. *Journal of Education and Practice*, 6 (15), 106-117, ISSN: 2222-288X

- Soroush, S. & Fatemeh, A. (2013). Do They Know that they Know? EFL Learners' Attitude Towards Concept Mapping in Listening Comprehension. *International Journal of Research Studies in Educational Technology*, 2 (1), 57-70, ISSN: 2243-7738
- Stegenga, J. (2015). Measuring Effectiveness. *Studies in History and Philosophy of Biological and Biomedical Sciences*, 54, 62-71
- Tabachnik, B.G. & Fidell, L.S. (2007). *Using Multivariate Statistics*. (5th Edition). Boston: Pearson Education
- Taipjutorus, W., Hansen, S. & Brown, M. (2012). Investigating a Relationship between Learner Control and Self-efficacy in an Online Learning Environment. *Journal of Open, Flexible, and Distance Learning*, 16(1), 56 - 69
- Taylor, E. (2014). *The Correlation Between Self-Efficacy and the Academic Success of Students*. A Senior Honors Thesis for the Honors Programme of Liberty University
- Tenaw, Y.A. (2013). Relationship Between Self-Efficacy, Academic Achievement and Gender in Analytical Chemistry at Debre Markos College of Teacher Education. *AJCE*, 3(1)
- Trifone, J.D. (2006). To What Extent can Concept Mapping Motivate Students to Take a More Meaningful Approach to Learning Biology? *The Science Education Review*, 5(4), 122:1-13
- Twoli, N. (2006). *Teaching Secondary School Chemistry: A text book for Chemistry Teachers in Developing Countries*. Nairobi: Nehema Publishers.

- Waaktar, T. (2013). Self-Efficacy is Mainly Genetic, Not Learned: A Multi-Rater Twin Study on Causal Structure of General Self-efficacy in Young People. *Twin Research and Human Genetics*, 16 (3), 651 - 660.
- Wambugu, P., Changeiywo, J.M. & Ndiritu, F.G. (2014). Effects of Experiential Cooperative Concept Mapping Instructional Approach on Secondary School Students' Motivation in Physics in Nyeri County, Kenya. *Journal of Education and Practice*, 5 (15), 74-84, ISSN: 2222-1735
- Wasike, D. (2013). *The Effect of Computer Assisted Instruction on Students' Learning of Mathematics among Secondary Schools in Bungoma County*. Unpublished PhD Dissertation, Masinde Muliro University of Science and Technology, Kakamega, Kenya
- Wilcox, R.R. (2010). *Fundamentals of Modern Statistical Methods: Substantially Improving Power and Accuracy*. (Second Edition). London: Springer
- Wilson, A. & Kim, W. (2016). The Effects of Concept Mapping and Academic Self-Efficacy on Mastery Goals and Reading Comprehension Achievement. *International Education Studies*, 9 (3), 12-23, ISSN: 1913-9020
- Wilson, B.G. (Ed.). (1996). *Constructivist Learning Environments: Case Studies in Instructional Design*. New Jersey: Educational Technology Publications
- Zadeh, N.R., Gandomani, H.S., Delaram, M. & Yekta, Z.P. (2015). Comparing the Effect of Concept Mapping and Conventional Methods of Nursing Students' Practical Skill Score. *Kashan University of Medical Sciences*, 4 (3), 1-6

APPENDICES

Appendix 1: Researcher's Introduction Letter



MASINDE MULIRO UNIVERSITY OF SCIENCE AND TECHNOLOGY (MMUST)

Tel: 056-31375
Fax: 056-30153
E-mail codsciencemaths@mmust.ac.ke
Website www.mmust.ac.ke

P.O Box 190
Kakamega – 50100
Kenya

Department of Science and Mathematics Education

Our Ref: MMU/COR: 524008

Date: 8th June, 2016

TO WHOM IT MAY CONCERN

RE: MR. MASINDE JOSEPH WANGILA - ADM No. EDS/H/02/15

The above named is a postgraduate student in our department, undertaking a Doctor of Philosophy (PhD) degree in Science Education (Chemistry option). He has embarked on a baseline study for his impending research entitled "*Software-Oriented Concept Mapping: A Metacognitive Strategy in Students' Learning of Electrochemistry among Secondary Schools in Kakamega County.*" Any assistance given to him by your office will be of great importance to him, the university and stakeholders in the Kenyan education sector and will therefore be highly appreciated. Thank you in advance.

Yours sincerely,



DR. CATHERINE AURAH,

Chairperson, Department of Science and Mathematics Education

Appendix 3: Research Authorization Letter



NATIONAL COMMISSION FOR SCIENCE, TECHNOLOGY AND INNOVATION

Telephone: +254-20-2213471,
2241349,3310571,2219420
Fax: +254-20-318245,318249
Email: dg@nacosti.go.ke
Website: www.nacosti.go.ke
when replying please quote

9th Floor, Utalii House
Uhuru Highway
P.O. Box 30623-00100
NAIROBI-KENYA

Ref. No. **NACOSTI/P/17/88749/15651**

Date:

9th February, 2017

Masinde Joseph Wangila
Masinde Muliro University of
Science and Technology
P.O. Box 190-50100
KAKAMEGA.

RE: RESEARCH AUTHORIZATION

Following your application for authority to carry out research on *“Influence of software oriented concept mapping on performance in electrochemistry among secondary school students in Kakamega County, Kenya,”* I am pleased to inform you that you have been authorized to undertake research in **Kakamega County** for the period ending **9th February, 2018.**

You are advised to report to the **County Commissioner and the County Director of Education, Kakamega County** before embarking on the research project.

On completion of the research, you are expected to submit **two hard copies and one soft copy in pdf** of the research report/thesis to our office.

BONIFACE WANYAMA
FOR: DIRECTOR-GENERAL/CEO

Copy to:

The County Commissioner
Kakamega County.

The County Director of Education
Kakamega County.

National Commission for Science, Technology and Innovation is ISO 9001:2008 Certified

Appendix 4: Map of the Research Area

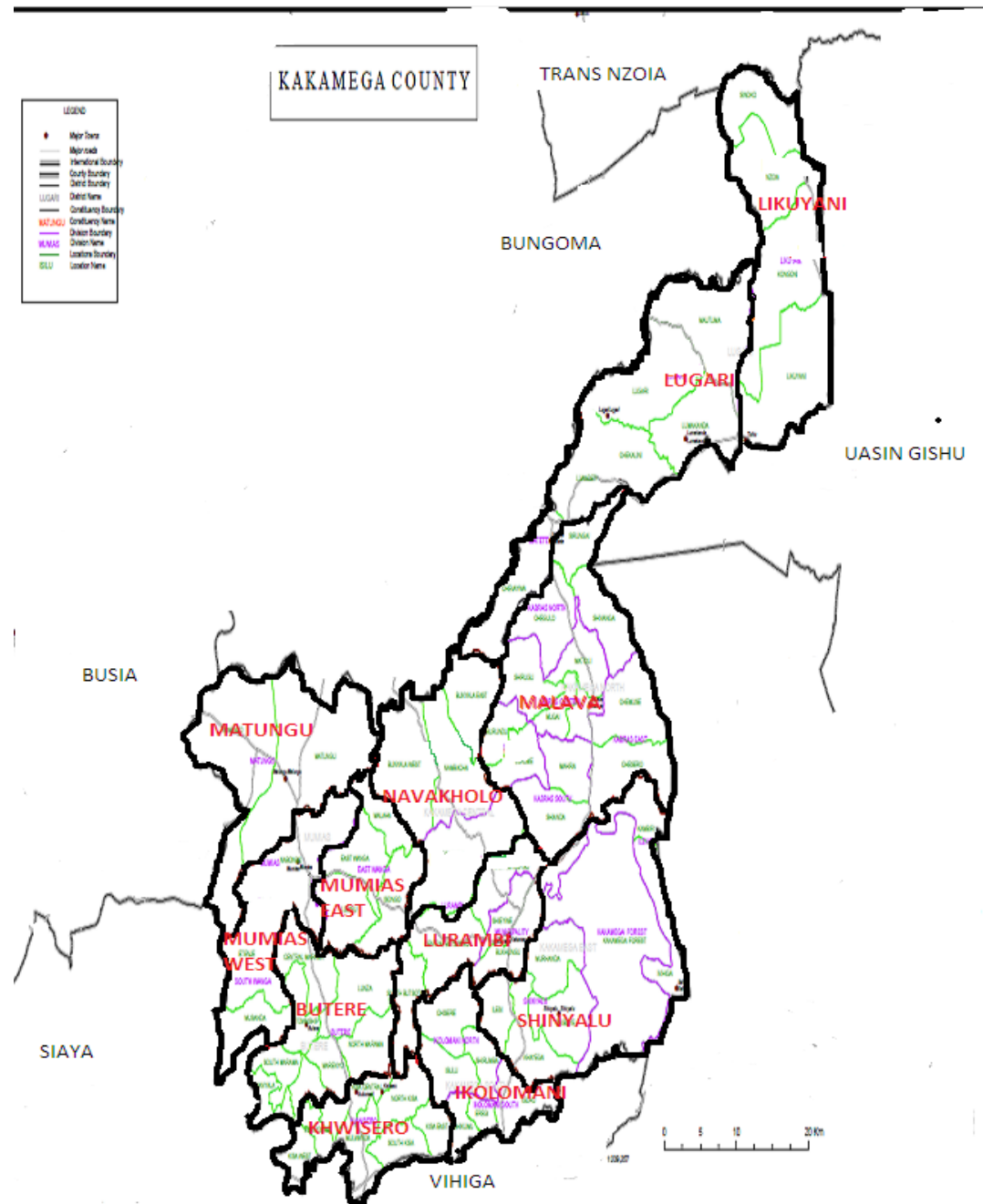

(Inset) Location of the research area on the Kenyan map

Appendix 5: Students' Self-Efficacy Questionnaire (SSEQ)

INTRODUCTION

This questionnaire aims to collect data concerning your beliefs in several aspects of Chemistry. Your cooperation in completing it with sincerity is very important. Findings will be treated very confidentially. Do not write your names on the questionnaire. Instead, use pseudo names provided. Place a tick against your most favorable response to each of the statements.

SECTION A: STUDENTS' DETAILS

Pseudo Name: _____

Gender: (*TICK ONE*) Female [] Male []

School Type: (*TICK ONE*) Mixed [] Girls' [] Boys []

SECTION B: THE STATEMENTS

STATEMENTS		Strongly Agree	Agree	Not Sure	Disagree	Strongly Disagree
1	I seek to connect what I learn in a Chemistry classroom with out-of-class science activities					
2	I never seek to connect what I learn from out-of-school science activities with what happens in the Chemistry classroom.					
3	I seek to connect my experiences at home with Chemistry lessons.					
4	I never seek to connect the information learnt in Chemistry topics with what I already know.					
5	I seek to connect what I learn from out-of-class science activities with what happens in the Chemistry class					
6	I seek to connect what I learn in the Chemistry class with other science subjects					
7	I don't adjust my plan for revising Chemistry if I am not making the progress I think I should.					
8	I plan to evaluate my progress in Chemistry tests and assignments					

9	I try to understand clearly the aim of Chemistry questions before I work them out					
10	I don't evaluate my learning processes in Chemistry with the aim of improving them.					
11	I don't consider what type of thinking is best to use before I tackle a Chemistry question					
12	I consider whether or not a strategy is necessary for tackling a question in Chemistry					
14	I stop from time to time to confirm whether I still remember recently taught Chemistry concepts					
15	I try to think tricks that can help me remember difficult Chemistry concepts					
16	I always plan for the best time of day to revise Chemistry topics and understand the most					
17	I know what kind of Chemistry questions that will give me problems should they come in an exam.					
18	I know I can master the skills being taught in Chemistry.					
19	I believe I can do a good job on the assignments and tests in Chemistry.					
20	I believe I will receive an excellent grade in Chemistry test.					
21	I'm confident of understanding the most complex material presented by the teacher in Chemistry.					
22	I'm doubtful of understanding the basic concepts taught in Chemistry					

END OF THE QUESTIONNAIRE!

THANK YOU AND DON'T FORGET THE TOKEN!

© Masinde Wangila's doctoral study, 2017

Appendix 6: Students' Attitude and Motivation Questionnaire (SAMQ)

INTRODUCTION

The objective of this questionnaire is to find out your true feelings and level of appreciation of Chemistry as a subject. Your cooperation in completing it with sincerity is very important. Findings will be treated very confidentially. Do not write your names on the questionnaire. Instead, use pseudo names provided. Place a tick against your most favorable response to each of the statements.

SECTION A: STUDENTS' DETAILS

Pseudo Name: _____

Gender: (*TICK ONE*) Female [] Male []

School Type: (*TICK ONE*) Mixed [] Girls' [] Boys []

SECTION B: ATTITUDINAL ITEMS

STATEMENTS		RESPONSES				
		SA	A	U	D	SD
1	Chemistry is a difficult subject					
2	Chemistry concepts are easy to understand					
3	I fear Chemistry examinations					
4	Chemistry lessons are boring					
5	I hate Chemistry experiments					
6	I'm impressed by the grades I get in Chemistry					
7	I would drop Chemistry if it was made optional					

8	Chemistry lessons are too many and should be reduced					
9	I'm not sure of passing final Chemistry examination					
10	I revise Chemistry regularly					
11	I am confident the method we've recently been using to learn Chemistry is effective					
12	The methods used to teach Chemistry should be improved					
13	The methods I use to read Chemistry on my own are not good enough					
14	Most topics in Chemistry are confusing					
15	Chemistry is one of my favorite subjects					
16	I don't see why we learn some Chemistry topics					
17	Chemistry text books we use are ugly					
18	The Chemistry teaching aids we use do not help me understand what is being taught					
19	Chemistry teachers are very knowledgeable					
21	Chemistry symposia and discussions are a total waste of time					
22	I treasure my Chemistry notebooks very much					

PLEASE TURN OVER TO THE NEXT PAGE

SECTION C: MOTIVATIONAL ITEMS						
STATEMENTS		SA	A	U	D	SD
1	There is something interesting about chemistry lessons that catches my attention					
2	After a Chemistry topic is introduced, I feel confident that I will understand what will be taught					
3	Chemistry topics are so abstract, which makes it hard for me to pay close attention					
4	Chemistry knowledge is relevant to my future interests					
5	Chemistry experiments make me curious					
6	After each Chemistry lesson, I feel confident that I will pass in KCSE examinations					
7	The feedback I get from teachers makes me feel rewarded for my effort					
8	It is clear to me how Chemistry is related to things I already know in real life					
9	Most Chemistry topics have too much information, which makes it hard to pick out important concepts					
10	It feels good to successfully complete a chemistry topic					
11	Most Chemistry topics are not relevant to my needs because I already know most of them					
12	My Chemistry notes are too boring, which makes me lose interest in reading them frequently					

THIS IS THE END OF QUESTIONNAIRE

© Masinde Wangila's doctoral study, 2017

Appendix 7: Students' Entry Behavior Achievement Test (SEBAT)

FORM 4 CHEMISTRY TEST - 60 Marks Time: 1 hour Date: _____

PART A: INSTRUCTIONS

- *This document has 6 printed pages. Check to ensure you have all of them before you read any further*
- *You remain anonymous in this study, so do not write your names, index number or name of your school anywhere in this paper. Instead, use the pseudo name (code on the white sticker on the right hand side of your desk) and indicate your gender and school type by placing a tick in the appropriate bracket*
- *PART D of this document is a Chemistry test, which consists of 18 questions, please attempt all of them in the spaces provided below each question. If the spaces are not enough, ask for some full scups form your teacher. Remember to write your pseudo name and question number on the extra writing material too.*
- *Brief and clear answers will earn you more marks.*
- *Silent, non-programmable scientific calculators may be used where necessary*
- *Answer all questions in **English***
- *All forms of cheating are not allowed when attempting questions in part D.*

PART B: STUDENTS' PARTICULARS

Pseudo Name: _____ Gender (tick one): Female [] Male []

School Type: Mixed [] Girls' [] Boys' []

PART C: SCORE SHEET - FOR OFFICIAL USE ONLY*

Qn.	1	2	3	4	5	6	7	8	9	10	11	12	13	14	15	16	17	18	Total
MS	7	3	3	4	3	12	3	3	3	1	2	1	3	4	1	2	2	3	60
SS																			

MS=Maximum Score, SS=Students' Score, *for determination of internal consistency

PART D: THE QUESTIONS

1. The flow chart below shows how the various components of air can be separated on large scale. Study it carefully and use it to answer questions that follow

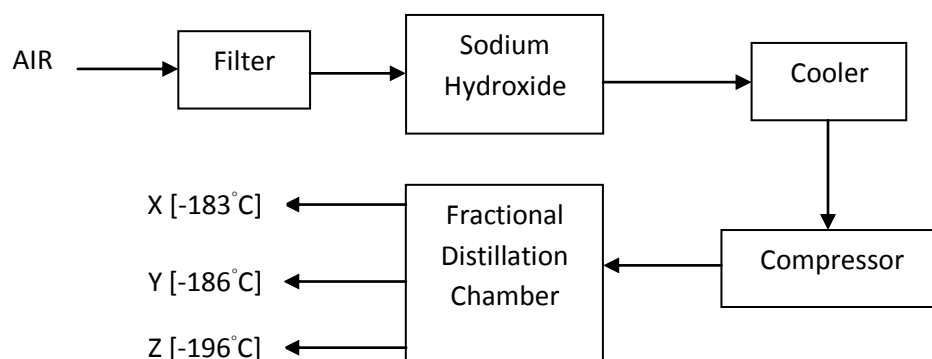

- a. State the role of the following; (3marks)
- Filter
 - Cooler
 - Compressor
- b. Name one example of a substance that can be used instead of sodium hydroxide (1 mark)
- c. Identify the following substances (3 marks)
- X _____
- Y _____
- Z _____

2. Explain how the following measures help in preventing rusting (3 marks)
- Painting
 - Galvanization
 - Applying grease

3. Give the names of the processes represented by the following chemical equations (3 marks)

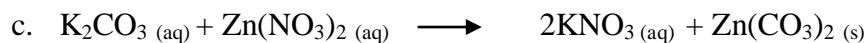
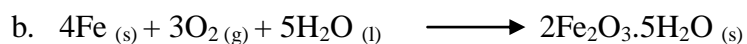
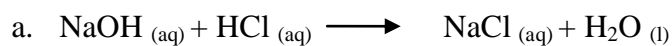

4. Define the following terms (4 marks)

a. Electrolysis

b. Binary electrolyte

5. Using dots (.) and crosses (×) to represent electrons, illustrate bond formation in an ammonium ion, NH_4^+ (3 marks)

6. The diagram below shows how sodium carbonate is prepared industrially by the Solvay process. Study it carefully and use it to answer questions that follow

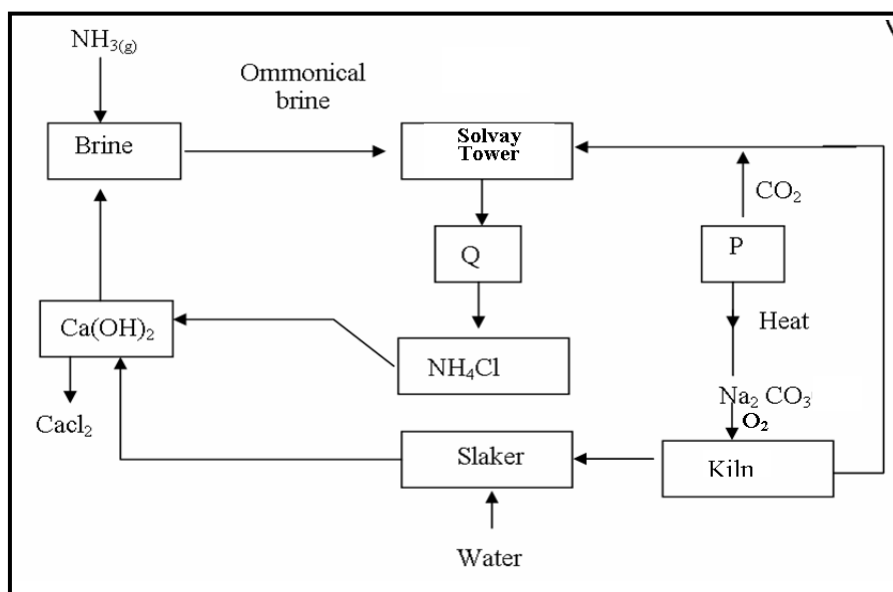

- a. State three raw materials that are recycled in this process (3 mks)
- b. Identify substance P (1 mark)
- c. Suggest a suitable location of a factory that carries out the Solvay process. Justify your answer (2 marks)
- d. Explain how ammonium chloride and sodium hydrogen carbonate can be separated from chamber Q (3 marks)
- e. Give three industrial use of sodium carbonate (3 marks)

7. Dry ammonia gas and dry oxygen gas were reacted as shown in the diagram below

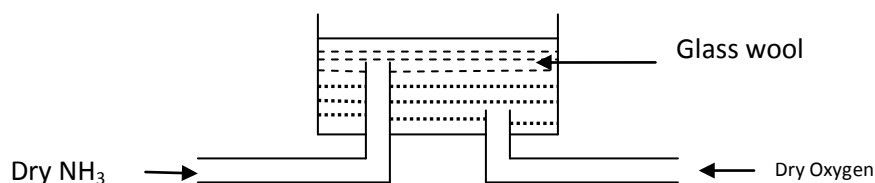

- a. What is the purpose of glass wool? (1 mark)
 - b. Name the products that would be formed if red hot platinum was introduced into a mixture of ammonia and oxygen (1 mark)
 - c. State one medical use of ammonia (1 mark)
8. A hydrocarbon contains 14.5% hydrogen. If the molar mass of the hydrocarbon is 56, determine the molecular formula of the hydrocarbon (C=12, H=1) (3 marks)
9. Calculate the mass of Zinc oxide that will just neutralize dilute Nitric (V) acid containing 12.6 g of Nitric (V) acid in water (Zn=65, O=16, H=1, N=14) (3 marks)
10. One of the allotropes of sulphur is monoclinic sulphur. Name the other allotrope (1 mark)

11. Concentrated sulphuric (VI) acid reacts with ethanol and copper metal. State the property of the acid shown in each case (2 marks)

a. Ethanol

b. Copper

12. State Grahams law of diffusion (1 mark)

13. It takes exactly 28 seconds for a given volume of carbon (IV) oxide to diffuse through a porous plug. Another gas, X, same in volume as the carbon (IV) oxide took exactly 2.5 minutes to diffuse through the same plug. Calculate the molar mass of gas X (C=12, O=16) (3 marks)

14. One piece of cotton wool was soaked in ammonia solution and another in concentrated Hydrochloric acid and placed on opposite ends of a tube as shown below

Ammonia

HCl

a. State and explain what would be observed in the tube (2 marks)

b. Write a chemical equation for the reaction responsible for the reaction in (a) above (1 mark)

c. Indicate with an X, the point where the observation in (a) above will be made (1 mark)

15. Which is the first member of the alkenes homologous series (1 mark)

16. Draw the structures of the following compounds (2 marks)

a. Propane

b. But-2-ene

17. Give the systematic IUPAC name of the following compound (2 marks)

i.

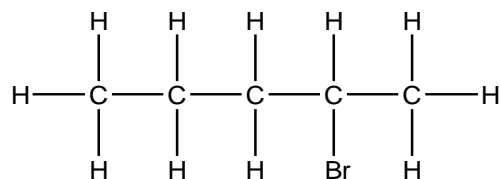

ii.

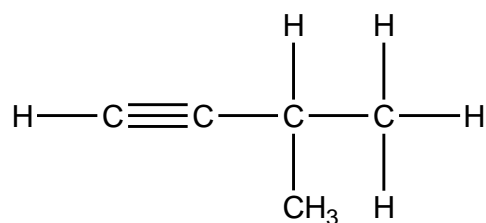

18. The table below shows behavior of metals R, X, Y and Z. Study it carefully and use it to answer questions that follow

Metal	Appearance on exposure to air	Reaction with water	Reaction with dilute HCl
R	Slowly tarnishes	Slow	Vigorous
X	Slowly turns white	Vigorous	Violent
Y	No change	No reaction	Does not react
Z	No change	does not react	Reacts moderately

a. Arrange the metals in their decreasing order of reactivity (1 mark)

b. Name a metal that is likely to be (2 marks)

i) X

ii) Y

THIS IS THE LAST PRINTED PAGE

© Masinde Wangila's doctoral study, 2017

Appendix 8: Marking Scheme for the SEBAT

1.
 - a.
 - i. Filter **removes dust** particles from the mixture- 1
 - ii. Cooler **removes water vapor** from the mixture by solidifying it onto ice-1
 - iii. Compressor **liquefies** the remaining gases in the mixture-1
 - b. Potassium hydroxide -1; accept calcium hydroxide
 - c. X – Nitrogen -1
Y – Oxygen -1
Z – Argon -1
2.
 - a. Painting locks out **water** -1
 - b. Galvanization locks out **air** -1
 - c. Applying grease locks out water -1
3.
 - a. Neutralization -1
 - b. Rusting -1
 - c. Precipitation -1; accept double decomposition
4.
 - a. Electrolysis is the **decomposition** of a substance in **aqueous or molten** state by passing electric **current** through it-1
 - b. Binary electrolyte is an electrolyte with only **one type of anion** and **one type of cation-1**
5. Labeling atoms - 1/2,

Dots and crosses - 1/2

Charge - 1/2

Correct illustration in square brackets - 1/2

6.

a. Raw materials recycled in this process

Water-1

Carbon (IV) oxide-1

Ammonia-1

b. NaHCO_3 - 1

c. Near a river -1,

To utilize running water as free raw material-1; accept other acceptable large water source -1

d. Filtration-1,

Crystallization-1

Different solubilities at different temperatures-1

e. Softening hard water-1; accept making glass

7.

a. To increase **surface area** for the reaction -1

b. Nitrogen (II) oxide -1; accept symbols

Water -1; accept symbols

c. Refrigerant -1

8.

Element	C	H
Percentage	85.5	14.5
Division by RAM	7.125	14.5
Division by 14.5	1	2

$$(12 + 2) n = 56$$

$$n = 4$$

∴ MF is C₄H₈

9.

$$\text{Moles of acid} = \frac{12.5}{1+14+48} = 0.1984 \text{ moles} \quad 1\text{mk}$$

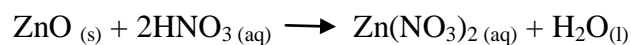

$$\text{Moles of ZnO} = \frac{0.1984}{2} = 0.0942 \text{ moles} \quad 1\text{mk}$$

$$\text{Mass of ZnO} = 0.0942 (65 + 16) = 7.6302\text{g} \quad 1\text{mk}$$

10. Rhombic - 1mk

11.

a. Ethanol-dehydrating agent - 1mk

b. Copper-oxidizing agent - 1mk

12. Under the **same conditions** of temperature and pressure, the rate of **diffusion**

of a gas is inversely proportional to the square root of its density-2mks

13.

$$\sqrt{\frac{44}{x}} = \sqrt{\frac{28}{150}} \quad 1 \text{ mk}$$

$$\frac{44}{x} = \frac{28^2}{150^2} \quad 1 \text{ mk}$$

$$x = \frac{150^2 \times 44}{28^2}$$

$$= 15.43 \text{ seconds} \quad 1 \text{ mk}$$

14.

a. Dense white fumes-1, due to formation of NH_4Cl -1



c. X placed in the tube, nearer to ammonia than to HCl -1

15. Ethene-1

16.

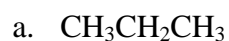

17. 2-bromopentane

3-methylbut-1-yne

18.

a. X, R, Z, Y - 1

b.

iii) Calcium -1

iv) copper-1; accept Hg, Ag, Au

Appendix 9: Students' Electrochemistry Achievement Test (SEAT)

Form 4 Electrochemistry Test - (30 Marks) Time: 1 hour Date: _____

PART A: INTRODUCTION AND INSTRUCTIONS

- This document has **FOUR** printed pages. Check to ensure you have all of them before you read further
- You remain anonymous in this study, so do not write your names or index number or name of your school anywhere in this document. Instead, use the pseudo name (code on the white sticker on the right hand side of your desk) and indicate your gender and age by placing a tick in the appropriate bracket
- PART D of this document is an exam, which consists of two sections; section I, which is theory and section II, which is a **SHORT** practical. Follow the directions of your teacher as to which section to start with.
- Brief and clear answers will earn you more marks.
- Non-programmable scientific calculators may be used where necessary
- Answer all questions in **English**
- All forms of cheating are not allowed when attempting questions in part D.

PART B: STUDENTS' PARTICULARS

Pseudo Name: _____ Gender (tick one): Female [] Male []

School Type: Mixed [] Girls' [] Boys' []

PART C: SCORE SHEET - FOR OFFICIAL USE ONLY*

QUESTION	1	2	3	4	5	6	7	8	9	10	TOTAL	
											Raw	%
MAXIMUM SCORE	2	2	2	9	1	3	3	1	4	3	30	100
STUDENT'S SCORE												

*For determination of internal consistency

PART D: THE QUESTIONS

SECTION I - THEORY (30 MARKS)

1. Define the following terms; (2 marks)
 - i. redox reaction,
 - ii. oxidation number
2. Determine the oxidation number of the element in brackets in each of the following compounds (2mks)
 - i. KMnO_4 , (Mn)
 - ii. $\text{K}_2\text{Cr}_2\text{O}_7$ (Cr)
3. Write a well-balanced chemical equation for the redox reaction that occurs when; (2 marks)
 - i. Aluminium displaces copper from a solution of copper (II) ions,
 - ii. Copper displaces silver ions from solution
4. The table below shows Standard Electrode Potentials for elements A, B, C, D and E, study it carefully and use it to answer the questions that follow.

Half equation	S.E.P
$\text{A}^{3+}_{(\text{aq})} + 3\text{e}^- \rightarrow \text{A}_{(\text{s})}$	- 2.16 V
$\text{B}^+_{(\text{aq})} + \text{e}^- \rightarrow \text{B}_{(\text{s})}$	- 3.81 V
$\text{C}_2_{(\text{g})} \rightarrow 2\text{C}^-_{(\text{aq})} + 2\text{e}^-$	+ 2.52 V
$\text{D}^+_{(\text{aq})} + \text{e}^- \rightarrow \text{D}_{(\text{aq})}$	+ 0.53 V
$2\text{E}^+_{(\text{aq})} + 2\text{e}^- \rightarrow \text{E}_2_{(\text{g})}$	0.00 V

- i. Select a pair of half-cells that when combined would form an electrochemical cell with the highest E.M.F. Give a reason for your answer (2 marks)
- ii. Calculate the E.M.F of the electrochemical cell drawn in (I) above (1 mark)
- iii. Draw a cell diagram for the electrochemical cell formed by combining half cells of B and C (2 marks)
- iv. Draw a well labeled electrochemical cell for the cell diagram in part (III) above (4 marks)
5. State one use of standard electrode potentials (1 mark)
6. Use the cell diagram below to answer the questions that follow

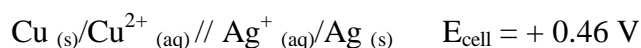

Given that the E^{θ} value for the $\text{Ag}^{+}_{(aq)} / \text{Ag}_{(s)}$ half-cell is + 0.80V, calculate the E^{θ} value for the copper half cell (3 marks)

7. Use the electrode potentials provided below to predict whether it is safe to store a solution containing ions of metal M in a container made of metal N.

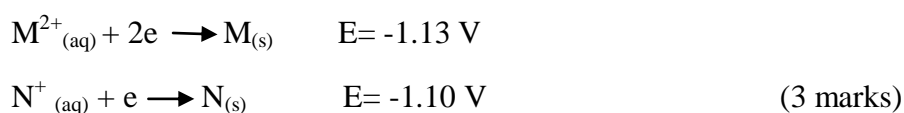

8. State Faraday's law of electrolysis (1 marks)
9. Calculate the volume of hydrogen gas that will be liberated at the cathode when a current of 0.8A is passed through aqueous magnesium nitrate for three hours? (M.G.V= 24,000 cm³) (4 marks)
10. In an experiment to electrolyze a molten chloride of metal N, a current of 0.2 Amperes was passed through it for 1930 seconds. The mass of the cathode

increased from 6.35 to 6.478g. Find the charge on the ion of metal N.

($F=96500C$, $M=64$)

(3marks)

SECTION II - PRACTICAL (25 MARKS)

11. You are provided with the following apparatus and chemicals;

Solution N, which is 0.5M copper (II) sulphate solution, solution M, which is 0.5M zinc nitrate solution, solution P which is saturated sodium chloride solution, two filter papers, two 50ml beakers, a voltmeter, electrical cables with, crocodile clips, a switch, a zinc rod, a copper rod, steel wool and labels

You are required to:-

- Construct an electrochemical cell using the copper and zinc as the half cells using the materials provided, (12 marks)
- Determine the E.M.F (Electro-Motive Force) of the electrochemical cell formed by connecting the zinc and copper half cells.(12 marks)

Procedure

- i) Measure exactly 30ml of solution N and place it in a clean 50ml beaker and label it as $CuSO_4$
- ii) Measure exactly 30ml of solution M and place it in a clean 50ml beaker and label it as $Zn(NO_3)_2$
- iii) Using clean electrodes and relevant apparatus, construct an electrochemical cell that combines zinc and copper half cells
- iv) Record the voltmeter reading in the space below (1 mark)

THE END

© Masinde Wangila's doctoral study, 2017

Appendix 10: Confidential for the Electrochemistry Practical

Apart from the normal fittings in the school laboratory, ensure that each student has or can access to the following (*to be used by students in question 11 of the SEAT*);

- One zinc rod
- One copper rod
- Two 50 ml beakers
- Two filter papers
- A paper stapler
- 35 ml of solution M
- 35ml of solution N
- Solution P
- A voltmeter
- 2 dry cells
- 4 electric cables
- A switch
- Steel wool
- 3 labels

Solution N is copper (II) sulphate solution, prepared by dissolving 50g of hydrated copper (II) sulphate pentahydrate crystals in 1 liter of distilled water. Supply each student with about 35cm³ of this solution in the 50ml beaker

Solution M is Zinc nitrate solution, prepared by dissolving 38g of Zinc nitrate crystals in one liter of distilled water. Supply each student with about 35cm³ of this solution in the 50ml beaker

Solution P is saturated sodium chloride solution, prepared by dissolving exactly 360g of sodium chloride crystals for about 5 minutes in one liter of distilled water. Filter to remove undissolved crystals. Supply 500cm³ of this solution as a bench solution to be used by all the students.

© Masinde Wangila's doctoral study 2017

Appendix 11: Marking Scheme for the SEAT

1a) A redox reaction is a reaction where oxidation and reduction occur simultaneously

b) Oxidation number is the apparent charge on a metal ion

2. i) $1 + x - 8 = 0$

$$x = +7$$

ii) $2 + 2x - 14 = 0$

$$2x - 12 = 0$$

$$x = +6$$

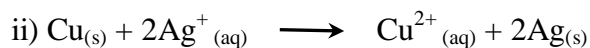
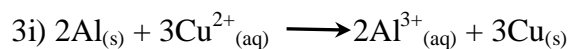

4 i) B and C because they are the strongest reducing and oxidizing agents respectively

ii) $\text{B}_{(s)} / \text{B}^{+}_{(aq)} // \text{C}^{+}_{(aq)} / \text{C}_{(s)} \quad E_{(\text{cell})} = + 6.33\text{V}$

iii) $E_{(\text{cell})} = 2.52 - 3.81 = + 6.33\text{V}$

5 i) To predict whether a reaction will occur or not

iii) To determine the reducing/oxidizing power of an element

iii) To calculate cell EMF of a given pair of half cells

6 $0.8 - x = 0.46$

$$x = 0.8 - 0.46$$

$$= + 0.34\text{V}; \text{penalize missing or wrong sign}$$

7. $EMF = -1.13 + 1.1 = -0.03V$ hence the reaction cannot occur since EMF is negative. It is therefore safe to store M^+ ions in a container made of N.

8. The mass deposited at the electrodes is directly proportional to the amount of current passed through the solution

9. $Q = 0.8 \times 6 \times 60 \times 60 = 8640$

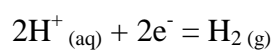

$$2 \times 96500C = 24000cm^3$$

$$8640C = \frac{8640 \times 24000}{193000} = 1074cm^3$$

10. $Q = 0.2 \times 1930 = 386C$

$$\text{Mass deposited} = \frac{0.28}{64} = 0.002 \text{ moles}$$

$$1 \text{ mole} = \frac{1 \times 386}{0.002} = 193000C = 2F$$

$$\therefore \text{Charge} = +2$$

Appendix 12: Manual for ‘MACOMASO’ Concept Mapping Software

Step 1: Creating Your Concept Map

To begin, open the software by double-clicking on “MACOMASO” on your desktop and select “diagram” on the resulting window.

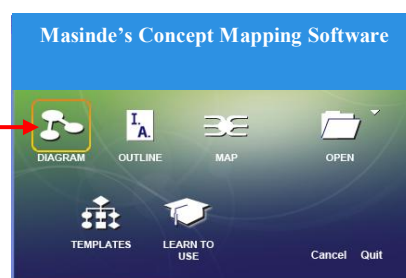

In the main idea box, type the word “*electrochemistry*”. Click on the oval at the top of the basic toolbar to create a new oval field on your concept map. Open it by selecting symbol palette under the pull down view menu. Add 1 term (a concept in electrochemistry) from the list to each oval created.

Step 2: Ranking and Linking Concepts

Arrange (by clicking and dragging) all of the ovals relative to the term “*Electrochemistry*” so as to create a main ideas/concepts’ scheme for electrochemistry. Use the link tool in the toolbar to create arrows between terms. First, click on the “link” button. Then click the object where you want the arrow to start, followed by a click on the object toward which the arrow should point.

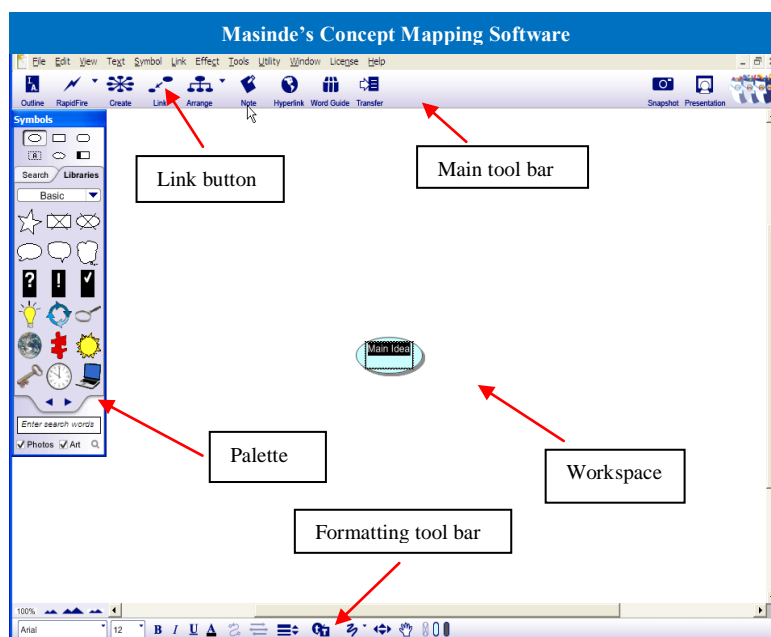

Step 3: Relationships

After completing your organizational scheme, write short phrases on the lines linking the concepts in your map. [NB: These conceptual links help illustrate students’ understanding of the relationships between the concepts in the map and can help clarify sources of confusion or misunderstanding e.g. does the student understand the difference between reduction and oxidation?]

Step 4: Finishing Up

Before printing the final concept map, you may wish to adjust the layout of your diagram by using the arrange choices from the top menu. When satisfied with the appearance of your work, print your concept map by selecting “file” on the tool bar then selecting “print” on the resulting menu. Note that the **Print Options** include a **Fit to One Page** choice, as well as both vertical and horizontal page layouts. More than one correct arrangement of these terms is possible. The point of the concept map is to allow you to express your understanding of the relationships between the terms/concepts or ideas. Save your map by selecting “save as” under the file tool.

Appendix 13: Students' Experimental Skills Checklist (SESC)

STUDENTS' PSEUDO NAME: _____

GENDER: MALE [] FEMALE [] School Type: Mixed [] Girls' [] Boys' []

SKILLS	STUDENTS' SCORE (Place a tick in the appropriate cell)				
	Excellent	Good	Fair	Poor	Very Poor
<p>1. Rinsing: The student should first wash the beakers and measuring cylinders using tap water, then rinse using distilled water, then dry them before using them</p>					
<p>2. Measuring: The student should use the 10ml measuring cylinder 3 times, followed by the 5ml once, should check the meniscus by raising the measuring cylinder to the eye level</p>					
<p>3. Polishing: The student should scrub the electrodes using steel wool provided before immersing them into the electrolyte</p>					
<p>4. Assembling The student should construct the cell by assembling the electric circuit as drawn in the figure below</p>					
<p>5. Recording: The student should record the EMF of the half electrochemical cell to 1 decimal place and indicate the units as Volts (V)</p>					

OVERALL SCORE: _____ (to be computed by the researcher)

Appendix 14: Focus Group Interview (FGI) Guide

(FOR THE EXPERIMENTAL GROUPS ONLY)

RESEARCH GROUP ID: _____

DATE: _____

FOCUS GROUP ID.: _____

INTERVIEW MODERATED BY: _____

I, Masinde Joseph Wangila, am conducting an evaluation of the influence of SOCM on students' performance in electrochemistry among schools in Kakamega county. This focus group will help me understand your attitudes, beliefs, perceptions, experiences, and feelings about the electrochemistry test you just sat for and other aspects that are important in your learning of Chemistry. Your insights will help your teachers make improvements in the way they teach you. You have been selected from among those students who completed the other instruments (questionnaires and tests). **The interview will take just 20 minutes!**

[May I begin or may we schedule a convenient time to complete the interview].

Anything you tell me is **confidential**. Nothing you say will be personally attributed to you in any reports that result from this focus group. All of my reports will be written in a manner that no individual comment can be attributed to a particular person.

There are no wrong answers but rather differing points of view. Please feel free to share your point of view even if it differs from what others have said. Keep in mind that I am just as interested in negative comments as positive comments and at times the negative comments are the most helpful.

You've probably noticed the voice **recorder** in my mobile phone. I will be recording the session so that I can study what you have said, but it goes no further than this group. Anything you say here will be held in strict confidence; I won't be telling people outside this room who said what. People often say very helpful things in these discussions and I can't write fast enough to get them all down. When you have something to say, please repeat your name each time. When I will be listening to the tape again I will not be able to see who is speaking, and I'll need to be able to relate comments you made at different times. It will be on a first name basis and I won't publish any names in my report. You may be assured of complete confidentiality. Your participation in this focus group is totally voluntary.

Do you have any questions before we begin?

PLEASE TURN OVER TO THE NEXT PAGE

INTERVIEW QUESTIONS

1. Please talk briefly about your experience in Chemistry classes.

Probe: How do you study for Chemistry?

2. What was your experience when taking the Electrochemistry test?

Probes: Did you feel challenged? Did all the questions make sense? What is the best strategy of tackling electrochemistry questions? Would you please tell me how you solved the problem in detail, for example, how you approached the problem at first, and how you came up with solutions?

On concept maps (for experimental group only)

3. In what ways did you find concept maps helpful in solving the questions?

Probes: Did you draw any concept maps? Do you think concept helped you arrive at the correct answer?

4. What did you like best about the electrochemistry test?

Probes: Did you look at the questions from different angles? What were your initial thoughts? Did you think of other ways of tackling the questions?

5. How confident were you that you'd do well when you started doing the test?

6. What difficulties do you experience when learning electrochemistry?

Probes: What steps have you taken to address these problems? Do all students experience the problems you have mentioned?

7. Have you ever addressed those difficulties?

Probes: How did you address the problems? Were you assisted? If yes, by who?

8. Do you have any other comments about electrochemistry and Chemistry in general?

Thank you very much for your time. I promise to use the information you have provided me to improve teaching and learning of electrochemistry in Chemistry at your school and the entire country in future.

(FOR THE CONTROL GROUPS ONLY)

RESEARCH GROUP ID: _____

DATE: _____

FOCUS GROUP ID.: _____

INTERVIEW MODERATED BY: _____

I, Masinde Joseph Wangila, am conducting an evaluation of the influence of the Conventional Instructional Strategies (CIS) on students' performance in electrochemistry among schools in Kakamega County. This focus group will help me understand your attitudes, beliefs, perceptions, experiences, and feelings about the electrochemistry test you just sat for and other aspects that are important in your learning of Chemistry. Your insights will help your teachers make improvements in the way they teach you. You have been selected from among those students who completed the other instruments (questionnaires and tests). **The interview will take just 20 minutes!**

[May I begin or may we schedule a convenient time to complete the interview].

Anything you tell me is **confidential**. Nothing you say will be personally attributed to you in any reports that result from this focus group. All of my reports will be written in a manner that no individual comment can be attributed to a particular person.

There are no wrong answers but rather differing points of view. Please feel free to share your point of view even if it differs from what others have said. Keep in mind that I am just as interested in negative comments as positive comments and at times the negative comments are the most helpful.

You've probably noticed the voice **recorder** in my mobile phone. I will be recording the session so that I can study what you have said, but it goes no further than this group. Anything you say here will be held in strict confidence; I won't be telling people outside this room who said what. People often say very helpful things in these discussions and I can't write fast enough to get them all down. When you have something to say, please repeat your name each time. When I will be listening to the tape again I will not be able to see who is speaking, and I'll need to be able to relate comments you made at different times. It will be on a first name basis and I won't publish any names in my report. You may be assured of complete confidentiality. Your participation in this focus group is totally voluntary.

Do you have any questions before we begin?

PLEASE TURN OVER TO THE NEXT PAGE

INTERVIEW QUESTIONS

1. Please talk briefly about your experience in Chemistry classes.

Probe: How do you study for Chemistry?

2. What was your experience when taking the Electrochemistry test?

Probes: Did you feel challenged? Did all the questions make sense? What is the best strategy of tackling electrochemistry questions? Would you please tell me how you solved the problem in detail, for example, how you approached the problem at first, and how you came up with solutions?

On the chalk and talk teaching strategy (for control group students only)

3. In what ways did you find approach helpful in solving the questions?

Probes: Did you use any teaching/learning aids? Do you think this helped you arrive at the correct answer? Did the lecture method make things worse?

4. What did you like best about the electrochemistry test?

Probes: Did you look at the questions from different angles? What were your initial thoughts? Did you think of other ways of tackling the questions?

5. How confident were you that you'd do well when you started doing the test?

6. What difficulties do you experience when learning electrochemistry?

Probes: What steps have you taken to address these problems? Do all students experience the problems you have mentioned?

7. Have you ever addressed those difficulties?

Probes: How did you address the problems? Were you assisted? If yes, by who?

8. Do you have any other comments about electrochemistry and Chemistry in general?

THE END

Thank you very much for your time. I promise to use the information you have provided me to improve teaching and learning of electrochemistry in Chemistry at your school and the entire country in future.

Appendix 15: Students' Informed Consent Form

I _____, declare that I have not been coerced in any way to participate in this research entitled, *“Influence of Software oriented concept mapping on performance in electrochemistry among secondary school students in Kakamega county, Kenya”*. My contribution is therefore purely voluntary, having had the researcher clearly explain to me the intention of this research and that all queries I had have already been answered to my satisfaction. I also have read a description of this research, which I do have a copy, and therefore give my consent to participate. I also have been given a copy of this consent form, to keep for my future reference. To the best of my knowledge, I meet the inclusion/exclusion criteria for participation (described below) in this study.

PARTICIPANT'S SIGNATURE

DATE

Description of research

This study is dubbed, *“Influence of Software oriented concept mapping on performance in electrochemistry among secondary school students in Kakamega county, Kenya”* It is being conducted in several schools in Kakamega county. The main purpose is to find out how teaching and learning strategies used in Chemistry may affect your performance in the topic of electrochemistry so as to make recommendations that can improve students' understanding of difficult topics.

Inclusion/Exclusion criteria

You qualify to participate in this study if;

- i) Your school is in Kakamega county
- ii) Your school has an average mean of 5 to 7 in KCSE for the last 4 years
- iii) You are aged between 17 and 22 years of age
- iv) Your parent has been informed or has no reservation about you participating in this study
- v) Your school offers computer studies*
- vi) You don't have eye problems for which a doctor has forbidden from using the computer*

** Applicable to those in the experimental group only*

Appendix 16: Request Letter to Experts for Validation of Instruments

Masinde Joseph Wangila,
Department of Science and Mathematics Education,
Masinde Muliro University of Science and Technology,
P.O Box 190-50100,
KAKAMEGA.
Date _____

Dear Rater,

RE: Assessment of Content Validity of My Research Instruments

I have identified you as a resource person in matters educational research. I am a doctoral student in the department of Science and Mathematics Education of Masinde Muliro University of Science and Technology. In my impending research, I plan to use the attached instrument, called _____, to collect data about _____.

I kindly request you to carefully read through the instrument, critique and rate each item therein, using the rating scale below after judging whether the items measure

_____.

My interest in the instrument is _____.

Feel free to include any other useful information below the table, concerning the overall validity of the test (whether the test measures what it purports to measure). Attached please find the abstract of my study.

Rating Scale:

1= Not Relevant; 2= Relevant; and 3= Very Relevant.

Please refer to the attached instrument(s) and fill the table provided overleaf, with the appropriate score, by marking with a tick under the selected score for each item.

Yours sincerely,

.....

MASINDE JOSEPH WANGILA

Admission Number: EDS/H/02/2015

Mobile Number: 0723 951 259

Email address: jossemasinde@yahoo.com

Rater's Name: _____ Institution: _____ Mobile: _____

Instrument: _____

ITEM NO.	COMMENTS(S)	VALIDITY SCORE		
		1	2	3
1				
2				
3				
4				
5				
6				
7				
8				
9				
10				
11				
12				
13				
14				
15				
16				
17				
18				
19				
20				
21				
22				
23				
24				

Any other comments (If any)

Thanks and God bless you Sir/Madam for your invaluable input

Appendix 17: Schools in the Research Area that Offer Computer Studies

1. St. Peters Mumias
2. Booker Academy
3. St. Ignatius Mukumu Boys
4. St. Paul's Emulakha
5. Musingu Boys
6. Kakamega School
7. Ingotse High
8. Mwitoti secondary
9. Moi Girls Nangili
10. Butere Boys
11. St. James Namamba
12. Chebuyusi Secondary
13. The Sacred Heart Mukumu Girls
14. Malava Boys
15. Eshinutsa Secondary
16. Bukaya Secondary
17. Shikoti Girls
18. Musoli Girls
19. Butere Girls
20. M.S. Bulimbo Girls
21. Kivaywa Boys
22. St. Kizito Lusumu
23. Mwiwila Boys
24. Shieywe secondary
25. Shikunga Secondary
26. Bushiangala Secondary
27. St Marys Mumias Girls
28. Kamashia Secondary
29. Lubinu Boys
30. St. Charles Khalaba Secondary
31. St. Mathew's Kholera Boys
32. Shikomari Secondary
33. St. Agnes Girls
34. Namasoli Secondary
35. Lwanda Secondary School
36. St. Joseph Girls Kakamega
37. Sidikho Secondary.
38. Shanderema Boys
39. Sisokhe Secondary
40. St. Pauls Lugari
41. Eregi Girls
42. Friends School Kongoni
43. Ekambuli Secondary
44. Matawa Secondary

45. Eshikulu Secondary
46. Sivilie Secondary
47. Malava Girls
48. Inaya Secondary
49. Muslim Boys
50. Imbale Secondary
51. Namirama Girls
52. Lirhanda Girls High School
53. St. Cecilia Girls
54. Mautuma Secondary
55. Eshisiru Secondary
56. Muslim Girls
57. Lirhembe Girls
58. Maraba Secondary
59. St. Phillip's Girls Mukomari
60. Kakunga Secondary
61. St. Annes Nzoia Girls Secondary
62. Mwangaza Secondary
63. St. Angela Secondary
64. Friends School Mukhonje
65. Kakamega Township Secondary

Appendix 18: Normality Tests for the Dependent Variables

Variable	Shapiro-Wilk		
	W	DF	P
Posttest Achievement Score	0.994	400	0.131
Posttest Self-Efficacy Score	0.992	400	0.033
Posttest Attitude Score	0.964	400	0.000
Posttest Motivation Score	0.996	400	0.379
Posttest Exp. Skills Score	0.993	400	0.460

Appendix 19: Test of Homogeneity of Variances on the Dependent Variables

VARIABLE	LEVENE STATISTIC	DF₁	DF₂	P
Posttest Achievement Score	6.191	1	398	0.211
Posttest Self-Efficacy Score	1.065	1	398	0.303
Posttest Attitude Score	0.319	1	398	0.572
Posttest Motivation Score	0.674	1	398	0.456
Posttest Exp. Skills Score	0.164	1	398	0.509

Appendix 20: Letter of Appreciation to Participants of the Study

MASINDE J WANGILA,

P.O. BOX 190-50100,

KAKAMEGA.

24th February 2017

To: All individuals/institutions that participated in my research

Dear Participant,

Following your active participation in my recently concluded study that was entitled **“Influence of software-oriented concept mapping on performance in electrochemistry among secondary school students in Kakamega county, Kenya”**, I write this letter to express my sincere gratitude. I take cognizance in the fact that your participation was purely voluntary, free-of-charge and might have inconvenienced you in some way. However despite your busy schedule, you were able to sacrifice some of your precious time, just to take part in my research and for that, I will forever be thankful.

Rest assured that findings of this study will go a long way in improving the quality of education in this country, with respect to the way Chemistry and other science subjects should be taught. Your efforts were therefore not in vain. In case you will be interested in my research findings, do not hesitate to contact me. My email address is jossemasinde@yahoo.com. Once again, thanks and God bless you. I wish you and your school all the best as you prepare for KCSE this year.

Yours sincerely,

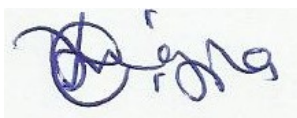

MASINDE, J.W.

The researcher

CC to: - School Notice Board

- Research Assistants**
- Head of Science Department**
- The Principal**

Appendix 21: Return Rates for the Research Instruments

Instrument	No. Administered	No. Returned	Return Rate (%)
SSEQ	400	400	100
SAMQ	400	400	100
SEBAT	400	400	100
SEAT	400	400	100
SESC	400	400	100
FGI Guide	10	10	100
Totals	2010	2010	100

Appendix 22: Completion Rates for the Research Instruments

Instrument	Number of Items therein	Average No. Responded to	Completion Rate (%)
SSEQ	22	21.56	98
SAMQ	34	32.98	97
SEBAT	18	15.30	85
SEAT	10	9.20	92
SESC	5	4.95	99
FGI Guide	8	8	100
Totals	97	91.99	94.83

Appendix 23: Incentive for Respondents of the Study

MY PERSONAL STUDY TIMETABLE

NAMES: _____
 SCHOOL: _____
 DREAM CAREER: _____
 ROLE MODEL: _____
 MOTTO: _____

DAY	MORNING (a.m)		EVENING (p.m)			
	4.00 - 5.00	5.00 - 6.00	5.30 - 7.00	7.00 - 8.00	8.00 - 9.00	9.00 - 10.00
MONDAY			Assignments			Consultation
TUESDAY			Assignments			Discussion
WEDNESDAY			Assignments			Consultation
THURSDAY			Assignments			Discussion
FRIDAY			Assignments			Consultation
SATURDAY						
SUNDAY						

TIPS ON HOW TO STUDY AND PREPARE FOR EXAMINATIONS

- i. Always have a timetable and follow it strictly. Remember failure to plan is planning to fail
- ii. Allocate more time for subjects you are weak in/ones you performed poorly in the previous test even if it is your favorite. This means your personal timetable should change from time to time
- iii. Science subjects should be scheduled for morning sessions because most of them are concepts-oriented which require fresh minds for maximum concentration.
- iv. Always have a notebook for making short notes that you can refer to any time of the day. It's easier to read short notes because they are a summary of main points. Always have the notebook on you.
- v. It's not possible to understand everything you read in a day. Therefore, always note down what you did not understand and consult your teacher as soon as possible. Frequent consultation is one of the best ways of creating a healthy teacher-student relationship and rapport.
- vi. Revise topically. This way you learn to relate all similar concepts. Thereafter, have a bank of as many questions as possible from the topic you just revised and ensure you can answer them all correctly. If not, **CONSULT! CONSULT!! CONSULT!!!**
- vii. Always spare time for rest and play. Remember all work without play makes you a very dull student.
- viii. Before you start preparing for any exam, look at the exam timetable. Read today for the paper you will do tomorrow and not next weeks'. However, do not wait until exam time for you to start reading seriously. Always keep in mind the 5 P's of preparation;

“Prior Planning Prevents Poor Performance”

DESIGNED AND DONATED BY **MR. MASINDE JOSEPH WANGILA**,
 A doctoral student at Masinde Muliro University of Science and Technology

See overleaf for all the bachelor's degree courses offered at our university

Appendix 24: Manual for Inspiration 9 Concept Mapping Software

Using Inspiration 9.0 software (Windows)

Inspiration is a powerful multimedia learning tool that allows students to develop ideas and organize thinking by creating organizer webs, concept maps, and diagrams. Templates are included that provide basic frameworks for researching, comparing, problem solving and more. The ability to brainstorm, hyperlink to the Internet, and convert diagram information into an outline are just a few of the tools and features that provide visual learners with a powerful resource for learning.

Please be sure to contact the school's instructional technology liaison to ensure that *Inspiration* software is installed in accordance with your school's licenses.

In this tutorial, a graphic organizer will be created to classify and describe different types of galaxies as described in the Earth/Space Science unit for Grade 6. We will also create a mind map of the causes and consequences of World War I as described in the Europe unit for Grade 7 World Cultures.

Contents	Page
Getting Started	Page 2
Adding Related Symbols	Page 3
Re-Arranging the Story Map	Page 4
Using Zoom Control	Page 4
Changing the Look or Shape of the Symbols	Page 4
Formatting Text	Page 5
Resizing Symbols	Page 5
Inserting Clipart	Page 6
Searching for Images from the Symbols Palette	Page 7
Browsing Images from the Symbols Palette	Page 7
Inserting Notes to a Diagram	Page 8
Using Spell Check	Page 8
Inserting Hyperlinks	Page 9
Hyperlinking an Object or Clipart	Page 10
Working in the Outline View	Page 11
Printing an Inspiration Document	Page 12

Saving an Inspiration Document	Page 12
Getting Started in Map View	Page 13
Working with Clip Art in Map View	Page 15
Working with Relationship Links	Page 15
Organizing your Mind Map	Page 16
Getting Started with the Presentation Manager	Page 17
Customizing your Presentation	Page 19
More Saving Options	Page 20

Getting Started



1. **Double-click** the *Inspiration 9* icon to open the *Inspiration* application.

The **Inspiration Starter** screen will appear. Options include creating a new diagram, outline, or map, opening existing *Inspiration* files, and accessing ready-made templates or online videos, curriculum packets, and other resources.



2. Click once on the **Diagram** icon in the upper left-hand corner.

- The **Diagram** view in *Inspiration* consists of four basic components: the starting point or work space, Symbol Palette, Main toolbar and Formatting toolbar.

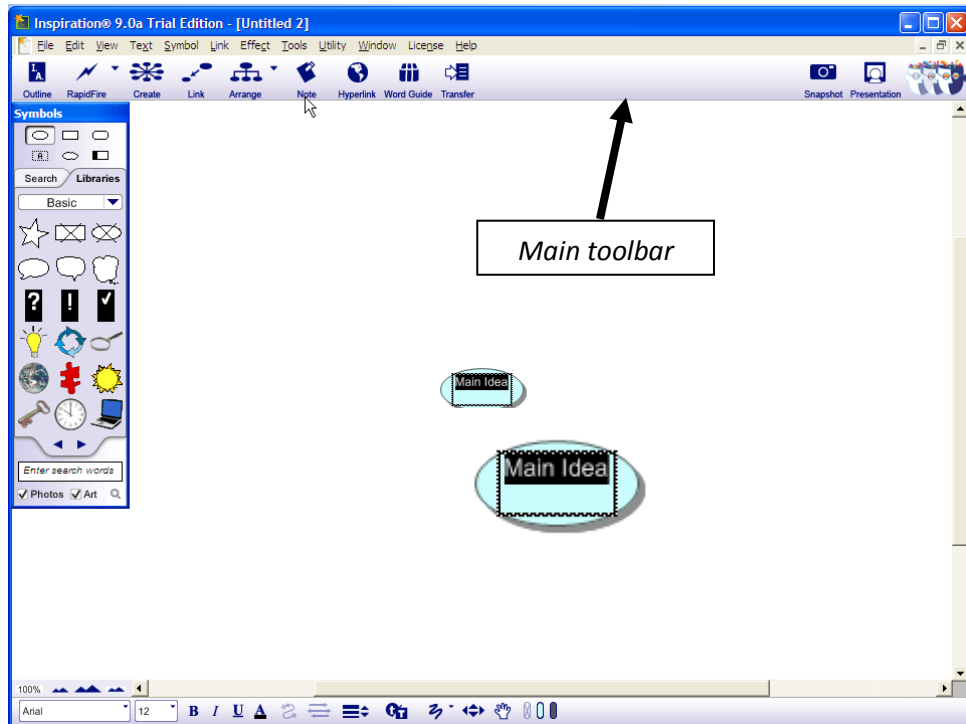

If the Symbol Palette is not visible, go to the **View** menu and select **Symbol Palette**.

- In the **Main Idea** symbol, type the title ‘Types of Galaxies’. The highlighted words ‘Main Idea’ will be replaced by the title of the story being described.

Adding Related Symbols

- Click on the shaded edge of the title symbol to select it. White “handles” will surround it.
- Click the **RapidFire** icon from the Main toolbar once. Notice that a lightning flash appears after the words in the selected symbol.
- Type the first galaxy group name, ‘Spiral,’ and press **Enter** on the keyboard.
- Type the second galaxy group name, ‘Elliptical,’ and press **Enter** on the keyboard.
- Type the third galaxy group name, ‘Irregular,’ and press **Enter** on the keyboard. New symbols containing the typed text will appear, linked from the title.
- Click once on the ‘Spiral’ symbol. Click the **Create** icon from the Main toolbar once. (Notice that each of the eight points on the button works like a separate tool. Clicking on one will make the new symbol appear on your diagram in the direction you chose.)
- Click once in the new symbol that appears and type ‘Looks like a pinwheel.’ This is the first of a handful of galaxy descriptions that we will add to the diagram.
- Click once on the ‘Spiral’ symbol again. Use the **Create** icon to make a second symbol. Type ‘Consists of a disk and a bulge.’
- Click once again on the ‘Spiral’ symbol. Use the **Create** icon to make a second symbol. Type ‘The Milky Ways is a Spiral Galaxy.’
- Repeat the process of adding descriptive information to the remaining galaxies using the data provided below.

Elliptical:

- Generally egg-shaped
- The galaxy shape is ranked from 7 (most elliptical) to 0 (almost circular)
- The largest galaxies in the universe

Irregular:

- Consist of odd-shaped galaxies
- Has no rotational symmetry
- In the Southern Hemisphere two irregular galaxies can be seen with the naked eye

Re-Arranging the Story Map

By now, the graphic organizer may look a bit jumbled. There are two options available to arrange the organizer into an easy-to-read tree:

15. Click and drag each symbol to the desired location... OR...
16. Click the **Arrange** button from the Main toolbar. Select **Split Tree** arrangement.
17. Press **OK**.

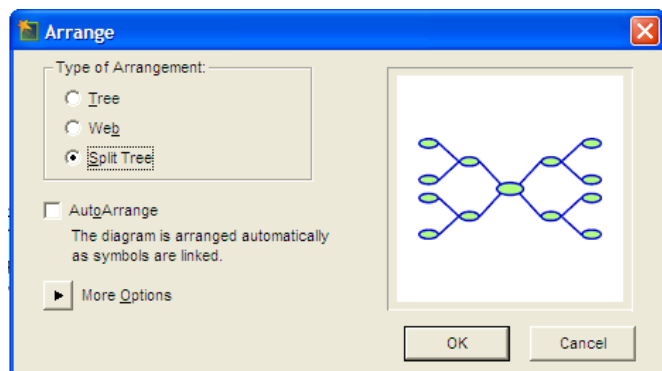

Using the Zoom Panel

Use this feature to re-size the screen. This has no effect on the final printed copy, but it allows for full view or close-up of the screen. Click the **Zoom** boxes on the Formatting toolbar at the bottom left-hand corner of the screen to change screen size. The third icon, **Fit to Window**, will automatically resize the diagram to fit the user's entire visible workspace.



Changing the Look or Shape of the Symbols

18. Select more than one symbol at a time by **Shift-Clicking**: hold the **Shift** key on the keyboard and click on each of the galaxy types.
19. Release the **Shift** key and notice that these three symbols now have square “handles” surrounding them.
20. Look at the **Symbol Palette** located on the left side of the *Inspiration* window. (Note: If the Symbol Palette does not appear, go up to the **View** menu and select **Symbol Palette**.) A set of six basic symbol shapes are available at the top of the Symbol Palette. Click the **rectangle** symbol.
21. **Shift-Click** the nine galaxy description symbols (three per galaxy). Select one of the other available shapes. Notice that, in addition to the six shapes at the top of the Palette, six more shapes are available for the **Basic Library** in the middle.



Formatting Text

To format text:

22. Click once on the symbol you want to format. Use the Formatting toolbar at the bottom of the page to change the font, style, size, and color. (If you don't see a Formatting toolbar on your screen, go to **View → Toolbar → Formatting**



23. Click once on the font, size, style, or color, and the associated menu will pop up. To change a setting click once. To change the text in multiple symbols, use shift-click to select the symbols.

Resizing Symbols

24. Click once on a symbol that is inadequately sized. Using the tip of the arrow as a guide, click and drag one of the square, white handles located at each corner of the symbol.

Inserting Clipart

25. Click once on the 'Types of Galaxies' symbol.
26. Click the menu arrow next to the **Library** title **Basic**.

27. From the pop-up menu that appears, select **Science**, then **Space Science**.

28. Click once on the **galaxy photo** in the bottom center of the Symbol Palette.

Notice how the oval-shaped symbol has been replaced by the galaxy photo and that the text appears below the image.

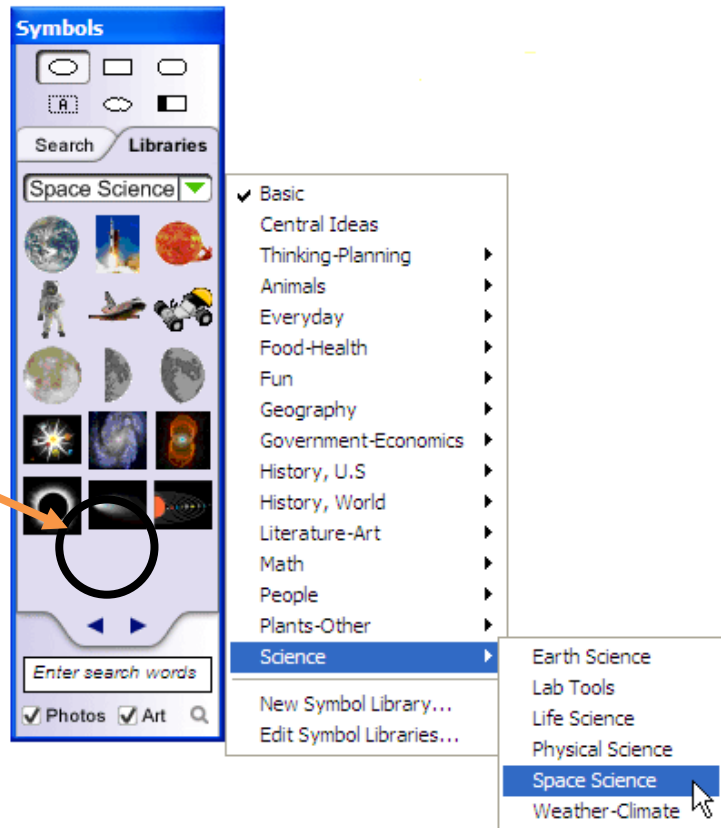

29. **Clip art** can also be clicked and dragged from the Symbol Palette and inserted into diagrams unconnected to the existing web. Click the **Astronaut** photo from the second row of images in the Symbol Palette and drag it onto the work space. Clip art can be resized by clicking and dragging one of the square, white handles located at each corner of the symbol. Clip art can also be inserted from other sources (*Microsoft Word*, the Internet, etc.) by copying and pasting individual images.

Searching for Images from the Symbol Palette

Inspiration 9.0 has over 1,200 photos and clipart images organized in various subject **Libraries** in the Symbol Palette. Images can be accessed through the **Libraries** or through a **Search**.

30. To conduct an image search, click on the **Search** tab located toward the top of the Symbol Palette.
31. In the text box at the bottom of the Symbol Palette, type the word 'space.'
32. Press **Enter** on the keyboard to process the search.
33. The number of images that match the search will appear on the top of the Symbol Palette. Use the blue **navigation arrows** at the bottom of the Symbol Palette to view additional results. Search results can be narrowed to only **Photos** or **Art** by deselecting the checkbox next to each. Additional searches can occur by deleting the existing text and typing in new search criteria.

Browsing Images from the Symbol Palette

The image Libraries can be browsed using the navigation arrows at the bottom of the Symbol Palette. Arranged liked an electronic Rolodex[®], the arrows move from one Library to the next based on the subject order in which they are arranged.

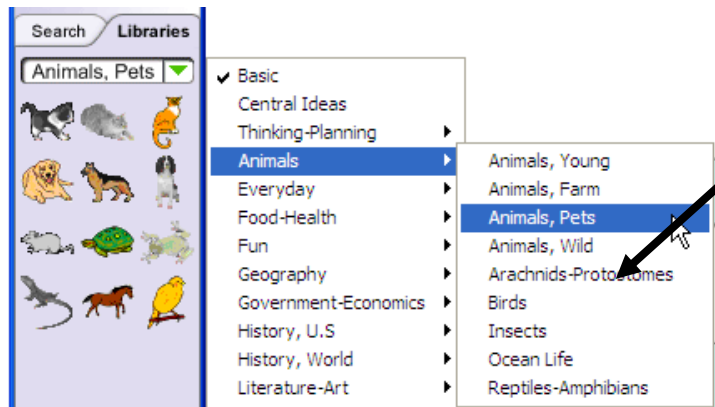

For example, view the **Animals, Pets** Library.

From this Library, clicking the right arrow will access to the next **Animals** Library, which is **Animals, Wild**.

Or, from the **Animals, Pets** Library, clicking the left arrow to the left will open **Animals, Farm**. (Select the **Libraries** Tab to access the browsing arrows.)

Inserting Notes to a Diagram

Inspiration has a **Notes** feature which allows users to add additional text without overpopulating the diagram. Notes can be “opened” and “closed” as desired.

34. Click once on the symbol ‘Looks like a pinwheel’ in the Spiral Galaxies descriptions.
35. From the tool bar, click the **Notes** icon. A yellow box, similar to a Post-It[®], note will appear.
36. Type “The bright nucleus of the galaxy (or center of the pinwheel) is often visible through a telescope or binoculars, but the spiral arms are dimmer and difficult to see.”
37. **Move** the note, so that it does not overlap other symbols, by clicking and dragging the title bar at the top.

38. The note can be automatically expanded to view all of the text by clicking the **double-arrow icon** that appears in the upper left-hand corner of the note.
39. The note can be closed by clicking the **X** in the upper left-hand corner of the note and reopened by clicking the **note icon** that appears in the upper right-hand corner when the symbol is selected.

Adding Linking Phrases

Inspiration 9.0 now includes built-in **Linking Phrases** that you can add to a diagram link’s label to easily explain relationships between symbols.

40. Right-click on the link between 'Types of Galaxy' and 'Spiral.' From the bottom of the menu, choose the **Linking Phrase** 'for example.' You can also find **Linking Phrases** under the **Link** menu.

Using Spell Check

Inspiration has a **Spell Check** feature similar to *Microsoft* products such as *Microsoft Word*, in which incorrect spelling is automatically underlined with a red, dotted line.

To access possible correct spellings for misspelled words, right-click on the red-underlined word. Left-click to select the correct spelling from the list of words provided. If the correct spelling is not provided in the list, the misspelling will need to be corrected or modified manually.

Inserting Hyperlinks

Hyperlinks can be added in symbols or notes to provide easy single-click access to web-based resources. This is ideal for teacher-created worksheets or for the inclusion of sources when conducting research.

41. Minimize *Inspiration* and open *Internet Explorer*.
42. Access a search engine such a *Google* at www.google.com.
43. Type in the phrase 'Windows to the Universe Galaxies' and press ENTER.
44. Locate and open the following web site.
http://www.windows.ucar.edu/tour/link=/the_universe/Galaxy.html.

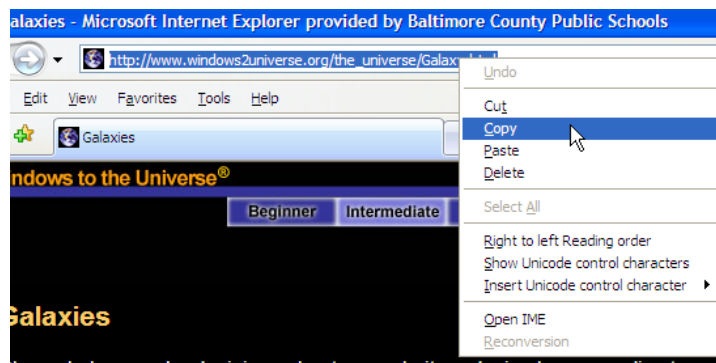

45. Click once in the **Address** bar to highlight the web site **URL**. **Right-click** on the highlighted address. Select **Copy** from the menu that appears.
46. Reopen the *Inspiration* diagram from the task pane at the bottom of the screen by clicking once on the *Inspiration* icon.
47. **Add a note** to the 'Types of Galaxies' icon. Select the symbol, and then click the **Notes** icon from the tool bar.
48. Right-click in the note that appears. Select **Paste**.
49. Press **ENTER** from the keyboard to activate the hyperlink. To open a hyperlink, hover over the URL until the cursor converts to a **link select** icon.
Note: This cannot occur if the note is 'blinking' with the **text select** icon. Click in the diagram background to deselect the note and to activate access to the hyperlink.

Hyperlinking an Object or Clipart

In addition to inserting a hyperlink directly into a symbol, the URL can be embedded in a symbol or clip art image. This eliminates the appearance of a lengthy web address.

50. Click once on the ‘Types of Galaxies’ symbol.
51. Select the **Hyperlink** button from the toolbar.
52. Select **Web Page** from the **Hyperlink Options**.

53. **Right-click** in the **Link to** field. Select **Paste** to paste the ‘Windows to the Universe’ URL from **step 44** in the previous activity.
54. Click **OK**. As with the URL described in the previous section, activate the hyperlink by hovering over the symbol until the cursor converts to a **link select** icon. This cannot occur if the text is ‘blinking’ with the **text select** icon. Click in the diagram background to deselect the symbol and to activate access to the hyperlink.

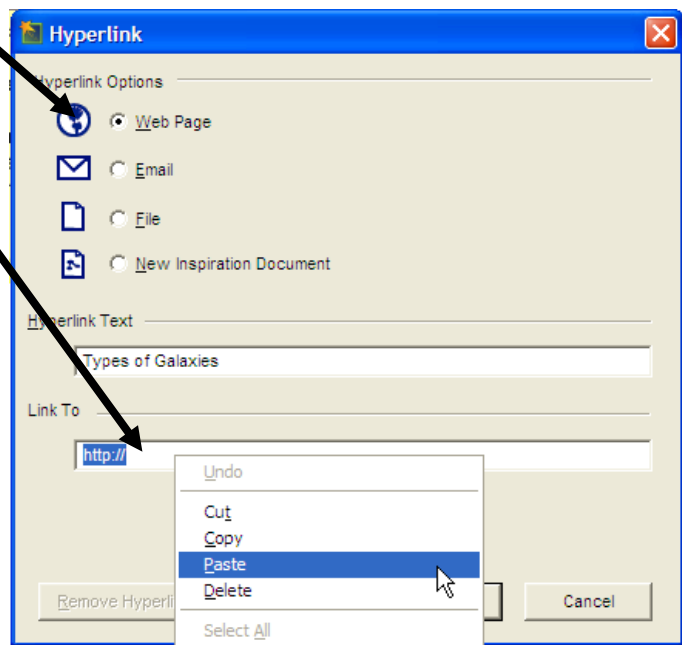

Working in the Outline View

Inspiration can easily convert a graphic organizer to an outline. This feature is especially useful for visual learners when organizing information for a research project or other informational document.

55. Move from the **Diagram** view to the **Outline** view by clicking the **Outline** button in the toolbar at the top left-hand corner of the screen.
56. To switch back to **Diagram** view, click the **Diagram** button on the top left corner of the toolbar. It is possible to add information while in the **Outline** view by clicking on the **Add Topic** or **Add Subtopic** icons and typing the new information. New information added in the **Outline** view will appear as new symbols upon return to the **Diagram** view.
57. You can see all of the connections you made in the **Diagram** view by displaying **Linking Phrases**. Press the **Show Link Text** button in the bottom toolbar to enable or disable the link text in your **Outline** view.
58. You can also visualize your connections while working on your outline by showing the symbols used in the **Diagram** view. Press the **Show Symbols** button in the bottom toolbar to enable or disable seeing the symbols in your **Outline** view.
59. In **Outline** view, you can easily split a single topic into two. Split the description ‘Consists of a Dish and a Bulge’ into two by clicking in the middle, and pressing the **Split** button.

Printing an *Inspiration* Document

To print an *Inspiration* document, it is convenient to have the entire document on one page.

60. From the **File** menu, choose **Page Setup**, and then select the **Layout** tab.
61. Select **Portrait** or **Landscape** orientation, and **Print Size 1 Page**. (Note: In *Inspiration 9*, this is the default setting.)
62. Select **Print Preview**.
63. Select **Print**. In the **Print** window, click **OK**.

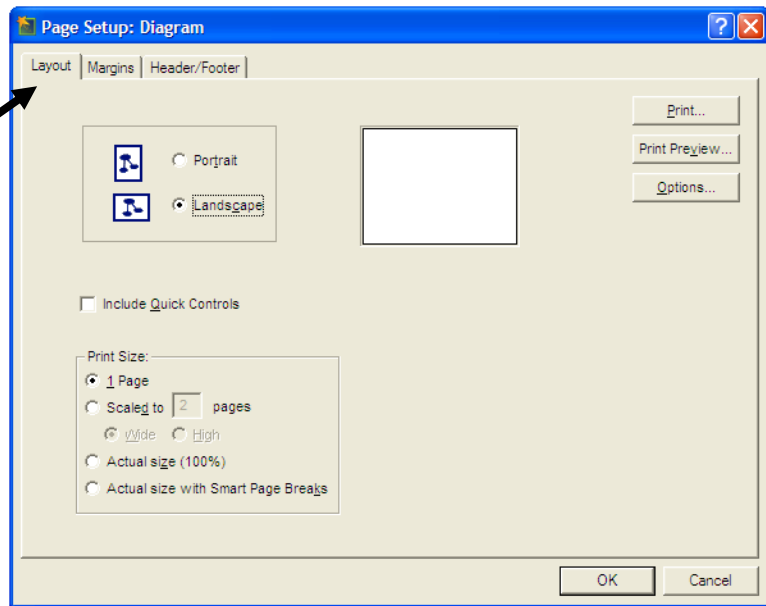

Saving an *Inspiration* Document

64. To save a document, choose **Save As** from the **File** menu.
65. In the **Save in** box, click the downward-facing arrow and choose a location from the scrolling list
66. Type a name for the file in the **File name** box.
67. Click the **Save** button. (Information from both **Diagram** and **Outline** views, as well as any **Notes**, will be saved.)

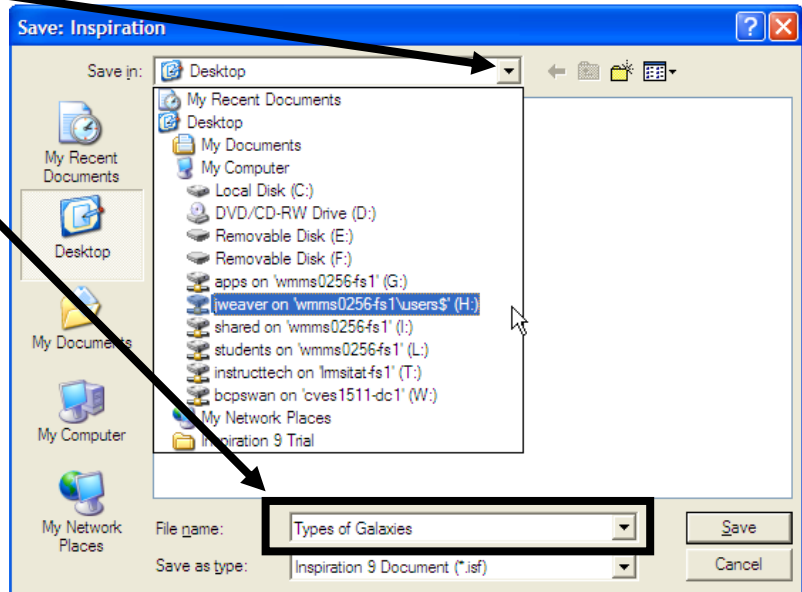

Getting Started in Map View

With *Inspiration 9.0*'s new mind mapping capabilities, you have the tools you need to build a mind map to visually represent an entire concept or idea with branches of associated thoughts. You can still do many of the same things in **Map** view that you can in **Diagram** view, but with a slightly different twist.

1. Go to the **File Menu** and select **New**.
2. From the **Inspiration Starter** window, select **Map**. The **Map** view in *Inspiration* consists of the same four components as the **Diagram** view: the starting point or work space, Symbol Palette, Main toolbar and Formatting toolbar. You will notice that some of the icons and symbols are slightly different. the **Central Idea** symbol, type the title 'Causes and Consequences of World War'
3. The highlighted words 'Central Idea' will be replaced by the title of this mind map.
4. Delete the red and orange branches by clicking on them and pressing the **Delete** or **Backspace** key on the keyboard.
5. **Click** the blue branch once to select it. A circle with a plus sign will appear on the end.
6. In the text box label that appears right above the branch, **type** 'Causes.'
7. **Click** on the purple branch once to select it and **type** 'Consequences' in the box that appears above it.
8. You can **move** each of the branches around by clicking on them and dragging them to a new location.
9. **Click** on the round **plus sign** at the end of the 'Causes' branch. This adds a subtopic or supporting idea.
10. **Click** on that same plus sign **three** more times so you have a total of four branches off of 'Causes.' You can also use the **Subtopic** icon in the toolbar to add branches.
11. In the text box label for each branch, **type** the following four causes:
 - Militarism
 - Nationalism
 - Imperialism
 - Alliances
12. **Repeat** this process to add four subtopics to the 'Consequences' branch:
 - Destruction and Casualties
 - Economic
 - Political
 - Social

Working with Clip Art in Map View

Notice that unlike in the **Diagram** view, in the **Map View**, the topics and subtopics are branches and not symbols. But you can still include clip art for each topic.

13. **Click** on the branch, 'Militarism,' so the white handles appear.
14. Go to the **Symbol Library** and **search** for 'tank.' **Click** once on a picture of a tank. Notice that the image of the tank now appears above the label 'Militarism.'
15. Clip art can also be dragged onto your mind map and attached to topics. **Search** the **Symbol Library** for 'soldiers.'
16. Select one of the pictures of soldiers and **drag** it over the 'Destruction and Casualties' branch. The text on the branch will turn green, which tells you that you are attaching the clip art to that topic. If you don't want to attach clip art to a topic,

it can be added unconnected to the existing web. Clip art can also be inserted from other sources (*Microsoft Word*, the Internet, etc.) by copying and pasting individual images. To remove clip art from a topic, **right-click** on it and select **Remove Symbol**.

Working with Relationship Links

17. **Click** on the branch, 'Militarism,' so the white handles appear.
18. **Click** on the **Relate** icon in the toolbar. A line will appear with your cursor.
19. **Move** your cursor to the 'Destruction and Casualties' branch until grey squares appear, then let go. You have now created a new relationship between topics on your mind map. Just like links in the **Diagram** view, you can edit and customize relationship links in the **Map** view.
20. **Right-click** on the relationship link between 'Militarism' and 'Destruction and Casualties.' Select the **Linking Phrase** 'causes' from the list at the bottom of the menu.
21. Click and drag one of the white circles to adjust the curve and shape of the relationship link
22. Use the **Thickness** button in the Formatting toolbar to increase the thickness of the line.

Organizing your Mind Map

23. To organize your mind map, **click and drag** the topics, symbols, or branches wherever you want them to be. Notice that if you move the topic, 'Causes,' all of the subtopics move with it.
24. Fixing mistakes and making changes to ideas is simple. **Click** on the subtopic, 'Social.' Now **drag** it over to the topic 'Causes.' When the topic turns green, let go and 'Social' will now be a new subtopic off of the main branch 'Causes.'
25. **Click** on the 'Consequences' branch once. Use the tools in the Formatting toolbar to change the **color** and **thickness** of the line, as well as the text **font**. Notice the subtopics change too.
26. **Click** on the subtopic 'Political.' Change its **color** and **font** to something different. Notice that subtopics can also be changed independently of the main topic.
27. In addition to manually moving your topics around in the **Map** view, there are some ways that *Inspiration 9.0* can help organize them.
28. **Drag** the three subtopics for 'Consequences' apart so they are spaced out.
29. **Shift-Click** those same three subtopics so that they are all selected and then **right-click** on them.
30. Select **Evenly Space** and **Vertical** from the drop-down menu.
31. While those same three subtopics are still selected, **right-click** again and select **Align** and **Right Sides** from the menu. Notice that the three branches are now evenly spaced and lined up to the same edge on the right side.
You can also find the **Align** and **Evenly Space** commands under the **Effect** menu.

Getting Started with the Presentation Manager

After you've created a diagram, outline, or mind map, you can convert it into a series of slides to present your ideas to a group. You are even able to use the stand-alone **Inspiration Presenter** application to control your slideshow on a computer that doesn't have *Inspiration 9.0* installed. (For more information on the stand-alone Presenter application, use the **Help** menu or see the *Inspiration 9.0* User Guide.

32. Click on the **Presentation** button in the **Main toolbar**.
33. The **Presentation Settings** window will appear. Select one of the designs and press **OK**. You will now see a presentation view of your mind map. Once again, there is a Main toolbar and Formatting toolbar. On the left is a **Slide Sorter**, which allows you to see all of your presentation slides. On the right are galleries. Each set of topics and subtopics now appears as a slide. A title slide was also added with the central idea 'Causes and Consequences of World War 1.'
34. **Click** on the second slide. Notice the empty box on the right side. From the **Snapshot Gallery**, find a picture of your mind map that matches the information on that slide.
35. **Click and drag** the snapshot onto the slide.
36. Do the same for the next two slides.

Customizing your Presentation

37. **Click** on the third slide.
38. Click on the text box to the left so it is selected, and click on the **Show/hide Talking Points Bullets** button on the Formatting toolbar. Notice that the bullets in front of each subtopic disappear.
39. Click on the **Reveal Talking Points** button on the Formatting toolbar. At first, it seems like nothing happened. But it did. You just "hid" the 5 subtopics (talking points) so when you present, you can reveal them one at a time to the audience. Let's see what that means.
40. Go back to the first slide. Press the **Play Presentation** button in the upper right corner of the screen.
41. **Click** your mouse, or use the space bar or the arrow key, to advance the presentation through the slides. Notice that the bullets on slide two are already on the screen, but on slide three, you have to click to make them appear.
42. Press the **Esc** key to end the presentation and return to the main view.
43. Select the **Choose Theme** tab from the galleries.
44. Choose a new presentation theme from the options that appear in the gallery.
45. Click on the second slide.
46. Select the **Choose Bullets** tab from the galleries.
47. Choose a new bullet format from the options that appear.
48. Click on the fourth slide.
49. Select the **Choose Layout** tab from the galleries.
50. Choose a new slide layout from the options that appear.
51. Click the **Back** button in the upper left corner to return to the **Map** view. All of your presentation settings and changes will be saved. You can return to the presentation view at any time by clicking on the **Presentation** button from the main screen.

More Saving Options

Saving your mind map is the same as saving a diagram or outline. Your work is always saved as an *Inspiration 9.0* file. However, there are other options for saving and viewing your work.

52. Just as in **Diagram** view, you can view and work with your mind map as an outline. Click on the **Outline** button in the toolbar.
53. To return to the **Map** view, click on the **Map** button.
54. In all three views, **Outline**, **Map**, and **Diagram**, you can press the **Transfer** button to transfer all or parts of your information into a word processor such as *Microsoft Word* or *OpenOffice.org*.
55. In the **File** menu, you can **Export to PDF File**, which turns your diagram into a graphic .pdf.
56. The **Export** option in the **File** menu lets you choose to export your information into **Presentation Slides** (that could be opened with *Microsoft PowerPoint*), **Web Pages**, or **Graphics Files**.

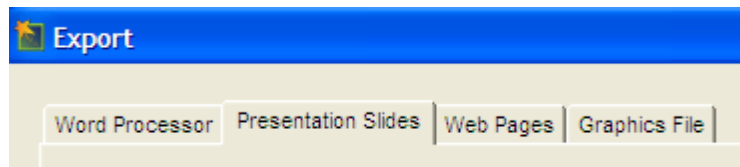

57. You will also notice that the **File** menu gives you the option of **Making a Diagram Document from your SOFTWARE DRAWN CONCEPT Map**, or **Making a Map Document from your Diagram!**
58. Whether you export your information or not, you should always save the *Inspiration* document itself by choosing **Save As** from the **File** menu.